

BEOSOUND BOLLARD

Installation Manual

BOHBLRZ | BOHBLRB | BOHBLRN

BOHBSLZ | BOHBLSB | BOHBLSN



BANG & OLUFSEN

ORIGIN
ACOUSTICS



CONTENTS

1. Introduction	●	1
2. Models & Specifications	●	2
3. What's Included	●	3
4. System Layout	●	4
5. Installation Guidance	●	4
6. Tap Settings	●	8
7. 70V vs 8Ω Wiring Options	●	8
8. 70V Wiring Setup	●	9
9. 8 Ω Wiring Setup	●	12
10. Painting Advisory	●	13
11. Troubleshooting	●	13
12. Technical Assistance	●	15
13. Limited 5 Year Warranty	●	16
14. Return Process	●	17

1. INTRODUCTION

Congratulations on selecting one of the finest outdoor speaker systems ever produced. The Bang & Olufsen | Origin Acoustics Beosound Bollard is a single unit that houses both a subwoofer and a mid/high frequency satellite in the same enclosure. The speaker is designed to allow the subwoofer section to be buried in the ground leaving only the pillar section exposed. The sound from both the sub and satellite emanates from the slots in the upper portion of the pillar section creating a uniform, full frequency sonic experience.

We take pride in providing you with a high-quality product. All of our speakers are designed to have excellent sound quality, longevity, and a simple installation process.

This instruction booklet covers the necessary information for a smooth installation, including: the tools you will need, step-by-step instructions for installation, troubleshooting tips for any errors that may occur, and all warranty information.

If for any reason you experience problems or if you have installation questions please call us at +1 (844) 674-4461.

Hours of operation are 8:00am to 5:00pm (Pacific Time), Monday through Friday.

2. MODELS & SPECIFICATIONS

The Beosound Bollard is available in:

- Round (BOHBLR) or Square (BOHBLS) Sleeve
- 360° Sound Dispersion

ROUND SLEEVE (BOHBLR):



Sleeve Color	Model Name	Sound Dispersion
Bronze	BOHBLRZ	360°
Black	BOHBLRB	360°
Natural	BOHBLRN	360°

SQUARE SLEEVE (BOHBLS):



Sleeve Color	Model Name	Sound Dispersion
Bronze	BOHBLSZ	360°
Black	BOHBLSB	360°
Natural	BOHBLSN	360°

*All product specifications are subject to change. Please refer to the dealer portal for the latest information.

ROUND MODELS

SQUARE MODELS

Subwoofer

Midrange

Tweeter

Frequency Response

Power RMS

Power Peak

Impedance

Transformer Taps

Round Sleeve

Square Sleeve

Subwoofer Enclosure

Enclosure Material

BOHBLRZ (Bronze) • BOHBLRB (Black) • BOHBLRN (Natural)

BOHBSLSZ (Bronze) • BOHBSLSB (Black) • BOHBSLSN (Natural)

6 1/2" (165mm) Polypropylene

4 1/2" (115mm) Aluminum

1" (25mm) PEI

48HZ - 20KHZ

60W

100W

6 Ω (Sub) / 4 Ω (Sat)

Selectable 8 Ω, or

70V: 50W/ 25W

Ø 5 1/2" (140mm) • 18 3/4" (476mm) Height

5 3/4" (146 x 146mm) • 18 1/2" (471mm) Height

Ø 12 1/2" (317mm)

8 3/8" (212mm) Depth

Poly Composite / Weather Resistant Enclosure

3. WHAT'S INCLUDED



Speaker



Wire Nuts (4)

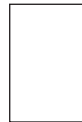

Installation Manual

*All product specifications are subject to change. Please refer to the dealer portal for the latest information.

RECOMMENDED TOOLS

- Direct Burial Wire
- Wire Stripper
- Shovel
- Speaker Wire
- Measuring Tape
- Screwdrivers

4. SYSTEM LAYOUT

Placement of the Beosound Bollard speakers throughout the exterior will depend on a couple of factors. The first is how uniform of a sound field is required. The laws of physics dictate that the further the listener is from the sound source the lower the apparent sound pressure level or “volume.” Because of this, there will always be areas with less sound and others with more. A greater number of speakers in the system will always ensure a more even coverage. The second factor is the desired maximum sound pressure required. Some systems are designed for background or ambient music, while others are designed to rock the house or provide dance music. Again, the number of speakers will affect the maximum output. Consider creating different zones, where music may be created louder in one area and softer in another, as required.

If you are concerned about determining speaker placement, B&O | Origin Acoustics offers a free design service to help you map the optimal speaker placements as well as recommended amplifier power and project scale.

Please email sales@originacoustics.com for more information.

5. INSTALLATION GUIDANCE

Once coverage and sound pressure requirements have been determined, the speaker locations can be selected. Before digging, confirm there are no subterranean obstructions such as water or gas lines, sprinkler pipes or electrical conduits. Holes for the subs should be deep enough to cover the entire lower section of the enclosure with approximately 1-inch of dirt on top of the that section. This will allow the pillar (shell) to protrude about 18-inches above the surface.

BURIAL INSTALLATION

Wire Length	Wire Gauge
0 - 100' (0 - 30m)	16
50 - 150' (15 - 45m)	14
Over 100' (30m)	12

5A. OPTIONAL DRAIN PLUG

The Beosound Bollard loudspeaker comes with a drain plug inserted at the bottom of its subwoofer enclosure. If there is water ingress for any unavoidable reason, removing the drain plug will allow for water to drain out. The drain plug is easily removable with a utility knife. Fully plan out the locations of all buried subwoofers and wires before beginning the installation process., and consider whether or not the Drain Plug may be necessary.

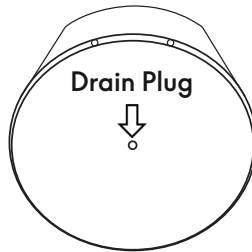

DRAIN PLUG REMAINS IN THE SUB ENCLOSURE

This option is recommended:

- In applications where ground water is at shallow depths and expected to rise easily above ground level or areas with overall very wet soil.

e.g. Areas of Houston, Louisiana

For Bollard with drain plug inserted:

1. Dig a hole for the subwoofer, about 18" in diameter and 18" deep.
2. Place the subwoofer as level as possible and not tilted.
3. Take care to fill empty spaces around drain hole where water might accumulate.
4. The subwoofer shouldn't be in contact with large rocks or large empty holes below the drain hole.
5. Use 2" of loose dirt to cover the top of subwoofer enclosure.

DRAIN PLUG IS REMOVED

This option is recommended:

- In applications with dry soil where occasional water may accidentally enter the enclosure. Use of gravel and sand will allow any water that gets into the sub enclosure to properly escape.

e.g. Las Vegas, Inland Southern California, Southwest desert

For bollard with drain plug removed:

1. Dig a hole for the subwoofer, about 18" in diameter and 18" deep.
2. Lay gravel rock (3/8" size recommended) for a depth of min. 3" below the bottom of subwoofer enclosure.
3. Place the subwoofer as level as possible and not tilted.
4. Take care to not block the drain hole by direct contact with gravel rock.
5. Use 2" depth of loose dirt to cover the top of subwoofer enclosure.

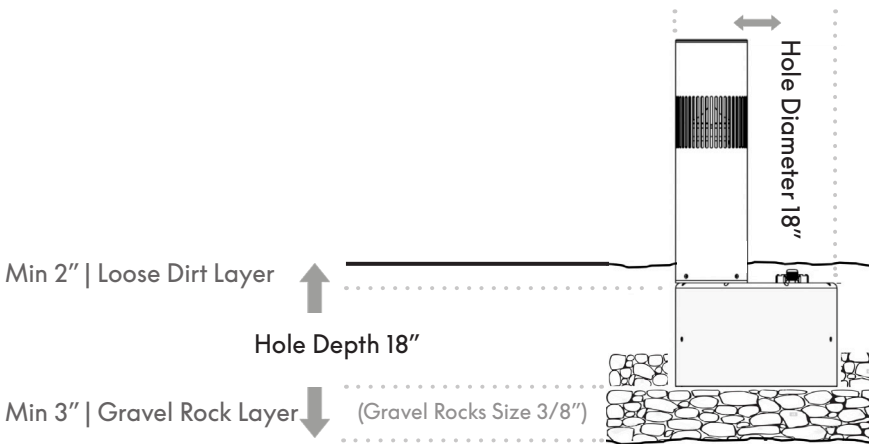

5B. BURIAL DEPTH

The subwoofer enclosure should be buried to a level where the dirt covers the wire nut and protruding wire at the top of enclosure. Do not bury excessively deep. Care should be taken to ensure that all bollards extend to the same height above ground.

NOTE: DO NOT BURY THE ENCLOSURE UNTIL ALL WIRING HAS BEEN COMPLETED.

5C. BOLLARD INSTALLATION: LOCATION

It is highly recommended that the speakers be installed at a location such that the water sprinkler nearby (if any) does NOT spray the water jet INTO or +/- 2 inches FROM vertical slots of the bollard shell. FOLLOW ILLUSTRATION BELOW:

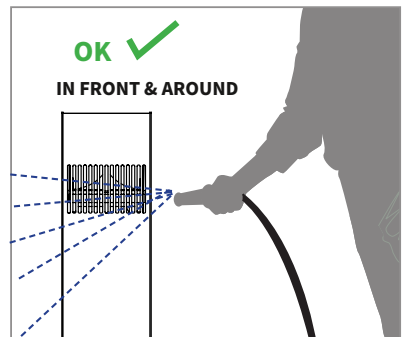
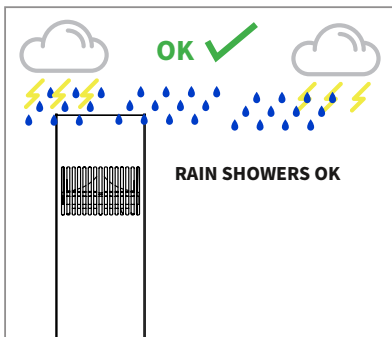
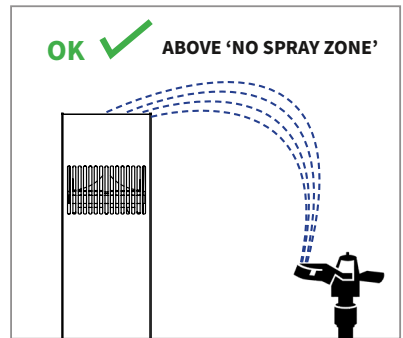
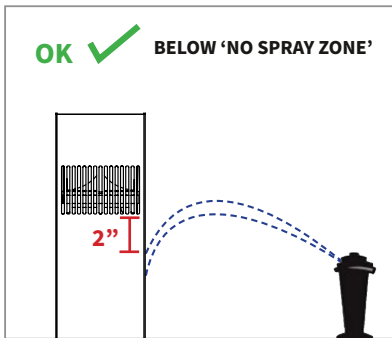
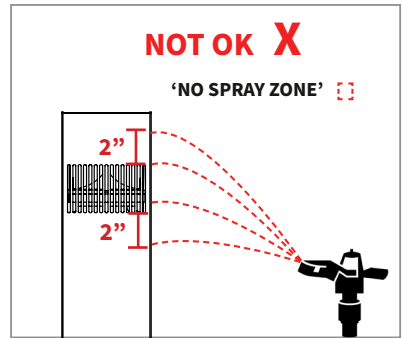
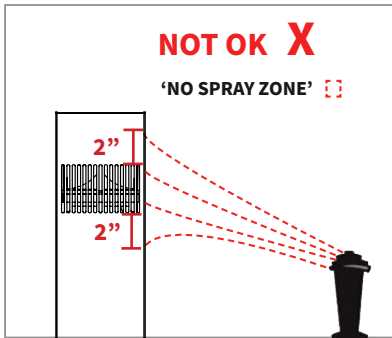

6. TAP SETTINGS

Each pair of wires connecting into the subwoofer and satellite portions of Bollard speaker is labeled as SUB IN and SAT IN respectively. To change the power tap setting, use the tap switch under the cap on the subwoofer.

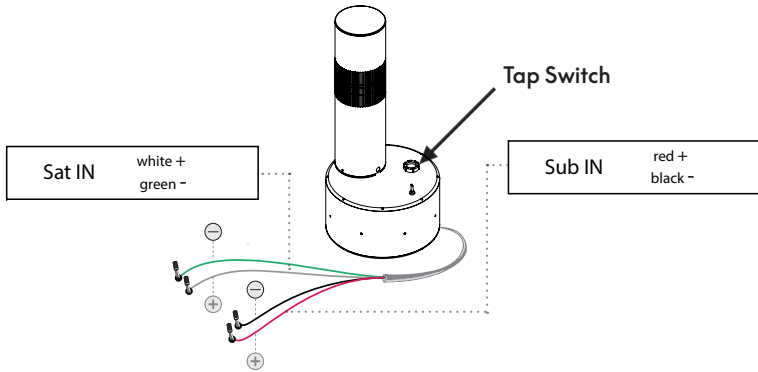

7. 70V VS 8 Ω WIRING OPTIONS

If you are looking to use more than 2 Bollard speakers, 70V is the proper solution.

In the Ohm (Ω) tap switch position, the transformers are bypassed. Due to the impedance in the 6 Ω (Sub) / 4 Ω (Sat) setting, **ONLY A SINGLE PAIR OF BOLLARDS CAN BE USED.**

To make sure the correct Bang & Olufsen tuning of the speakers are used it is highly recommended to only use the co-branded amplifiers from Bang & Olufsen | Origin Acoustics.

TAP SWITCH SETTING	RECOMMENDED AMP	MAX. NUMBER OF BOLLARD SPEAKERS
25 W (70V)	Beoamp 125.4 Amp	TOTAL 8 PER BEOA125 AMP (4 per Channel)
50 W (70V)	Beoamp 125.4 Amp	TOTAL 4 PER BEOA125 AMP (2 per Channel)
8 Ω (bypass)	Beoamp 125.4 Amp	TOTAL 2 PER BEOA125 AMP (1 per Channel)

*** WARNING: ONLY RUN A MAXIMUM OF 2 (TWO) BOLLARD SPEAKERS IN 8 Ω TAP SWITCH SETTING.**

8. 70V WIRING SETUP

- Use 1 separate wire run for:

Subwoofer portions of Bollards

- Use another separate wire run for:

Satellite portions of Bollards

The Beoamp 125.4 amplifier (BEOA125) from B&O | Origin Acoustics was specifically designed to drive the Beosound outdoor speaker systems. In 70V, it is the recommended amp for Subwoofer control and DSP for best performance.

The BEOA125 amplifier offers EQ and crossover presets specifically for the Beosound Bollards. These presets have active crossovers that remove the bass from the satellites and send that bass only to the subwoofers. This more effectively controls how the subwoofer interfaces with the satellites and permits you to control the subwoofer-to-satellite balance. The digital signal processing or “DSP” also shapes the sound for both subs and satellites to create optimum performance.

8A. 70V INSTALLATION NOTES

- The subwoofers and satellites will be run in **PARALLEL**.

This means the positive connection on the amplifier will be connected to the positive connection on speaker 1, 2, 3, etc. The negative connection will be connected to the negative connections on the speakers as well. This can be accomplished with a single pair of wires in a “daisy chain” where the amplifier is at one end and the speakers are connected consecutively.

- If desired, you can also wire in a star pattern where each speaker is directly wired back to the amplifier.

8B. 8 X BOLLARDS: (25W) 70V WIRING WITH BEOAMP 125.4

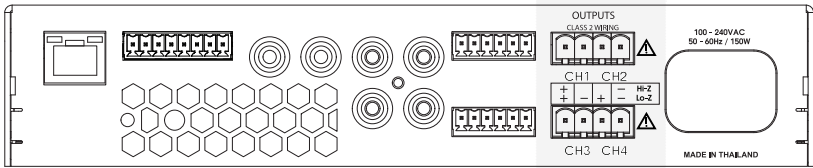

Amp Output mode set to Hi-Z -70V [Bridge mode]

- OUTPUT CH1/CH2 for Satellites
- OUTPUT CH3/CH4 for Subwoofers

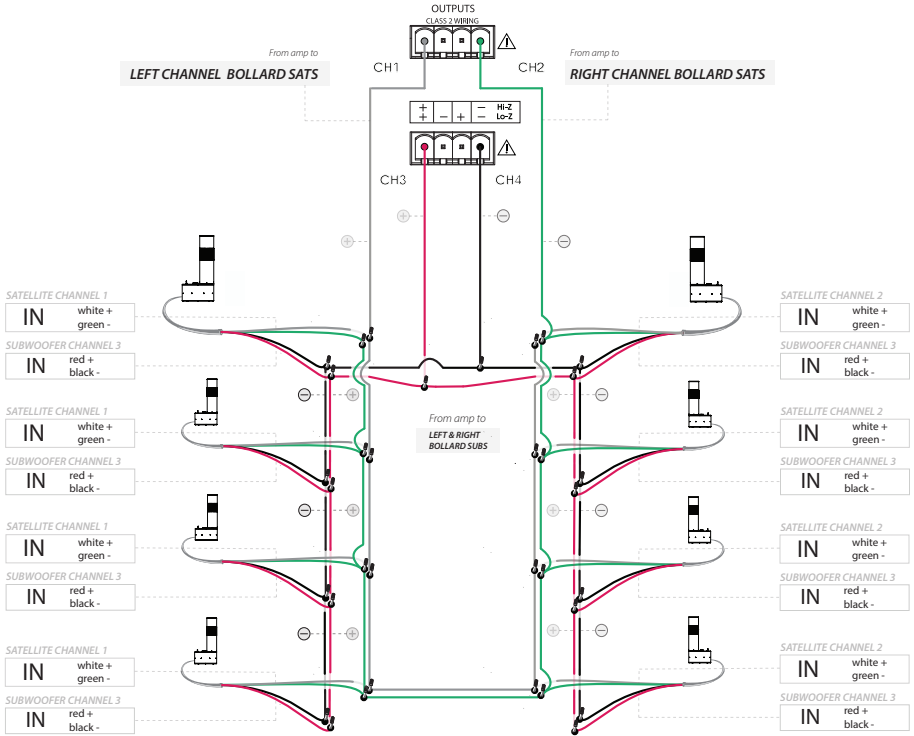

2 CHANNEL SETUP

MAXIMUM NUMBER OF BOLLARDS PER AMP: 8 BOLLARDS (25W TAP SETTING)

8C. 4 X BOLLARDS: (50W) 70V WIRING WITH BEOAMP 125.4

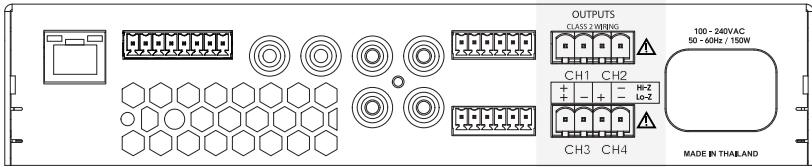

Amp Output mode set to Hi-Z -70V [Bridge mode]

- OUTPUT CH1/CH2 for Satellites
- OUTPUT CH3/CH4 for Subwoofers

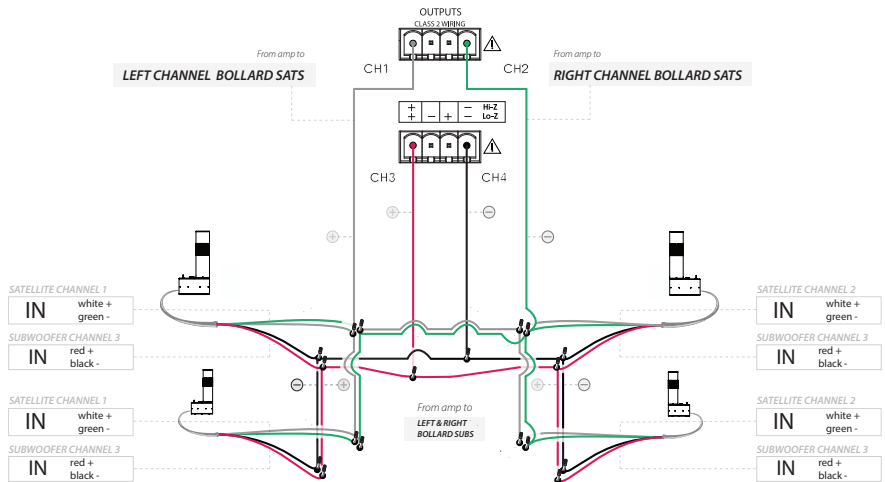

2 CHANNEL SETUP

MAXIMUM NUMBER OF BOLLARDS PER AMP: 4 BOLLARDS (50W TAP SETTING)

9.2 X BOLLARDS 8Ω WIRING WITH BEOAMP 125.4

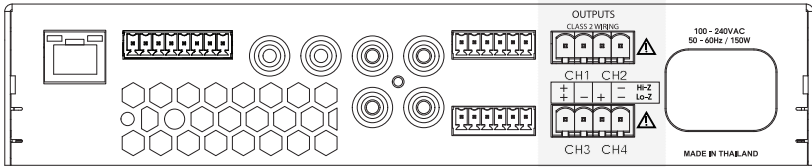

Amp Output mode set to Lo-Z [4~8 ohms]

- OUTPUT CH1 & CH2 for Satellite
- OUTPUT CH3 & CH4 for Subwoofer

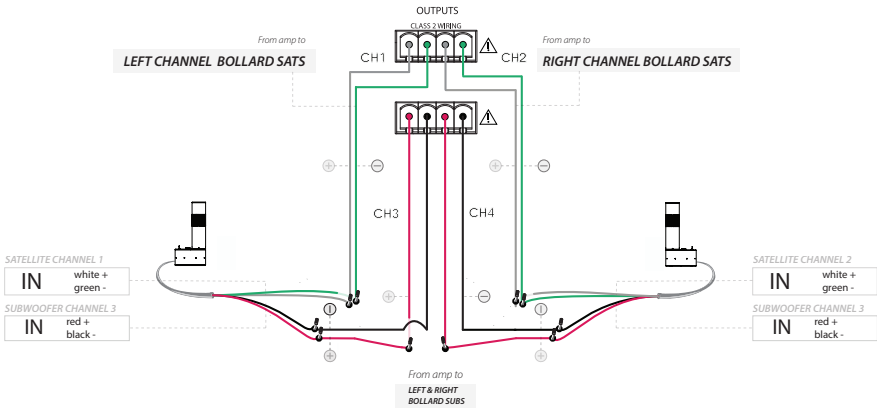

MAXIMUM NUMBER OF BOLLARDS PER AMP: 2

4 CHANNEL SETUP

* WARNING:

Run maximum 2 (TWO) Bollard speakers ONLY per Amplifier in 8 Ω Tap switch setting.

10. PAINTING ADVISORY

The outer shell (pillar) of the Beosound Bollard outdoor speaker is anodized specifically for achieving maximum durability of the pillar color. If you wish to change the color of the Beosound Bollard shell by painting or other process, it may compromise the durability and finish of the product compared to the original manufacturing process and modify the specifications.

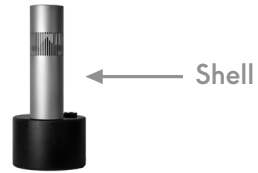

11. TROUBLESHOOTING

If you have a problem, try isolating it first. For example, if you're playing a DVD and there is no sound, try replacing the DVD with an MP3 player to see if you get sound. If it does work, then the problem is with the television, DVD player, or the cables connecting them. If it doesn't work, the problem will be with the amplifier, speakers, or those cables.

Problem	Possible Cause
No Sound	The volume may be turned down or muted. Check the volume settings on both the amplifier and the DVD player/television/computer/etc.
No Sound	Make sure the proper source is selected on the amplifier or receiver.
No Sound	Check the cord connecting the amplifier with the source. The cord may be damaged or plugged into the wrong input or output.
No Sound	Check the wires connecting the amplifier with the speakers. Make sure they're connected properly and not damaged in any way.
Poor Sound Quality	If you hear something like static, or the sound is cutting in and out, check the audio cables. If the problem increases when a cable is being moved, then the cable is most likely faulty or not connected properly.
Poor Sound Quality	Today's audio systems may have several places to adjust the volume, for example your MP3 player may have a volume control, and your amplifier may also have one. Check to be certain that the volume isn't turned up past 80% on any device.
Poor Sound Quality	Try changing sources to be certain that the selection you've chosen is a good quality recording.

12. TECHNICAL ASSISTANCE

If you have any questions or concerns about installing or using this product, you can reach us through one of the following methods:

Phone: +1 (844) 674-4461

Hours of operation: 8:00am - 5:00pm (Pacific Time), Mon - Fri

Email: sales@originacoustics.com

If you are having technical trouble, please include the model number and briefly explain what steps you took to resolve the problem in your email, or be prepared to answer these questions over the phone. If you are considering returning the product, it's required that you contact B&O | Origin Acoustics prior to any return attempts. This way we can determine if the issue can be resolved without returning the product, or if needed we can provide instructions and support for the return process.

13. LIMITED 5 YEAR WARRANTY

B&O | Origin Acoustics warrants to the original retail purchaser only that this B&O | Origin Acoustics product will be free from defects in materials and workmanship, provided the speaker was purchased from an B&O | Origin Acoustics authorized dealer.

If the product is determined to be defective, it will be repaired or replaced at B&O | Origin Acoustics' discretion. If the product must be replaced yet it is no longer manufactured, it will be replaced with a model of equal to or greater value that is the most similar to the original. If this is the case, installing the replacement model may require mounting modifications; B&O | Origin Acoustics will not be responsible for any such related costs.

13A. REQUIREMENTS & COVERAGE

This warranty may not be valid if the product was purchased through an unauthorized dealer. This warranty only applies to the individual that made the original purchase, and it cannot be applied to other purchases. The purchaser must be prepared to provide proof of purchase (receipt). This warranty will not be valid if the identifying number or serial number has been removed, defaced, or altered.

***ALL WARRANTIES AND WARRANTY CONDITIONS ARE SUBJECT TO CHANGE.
PLEASE REFER TO WEBSITE FOR THE LATEST INFORMATION.**

13B. NOT COVERED BY WARRANTY

- Accidental damage
- Damage caused by abuse or misuse
- Damage caused by attempted repairs/modifications by anyone other than B&O | Origin Acoustics or an authorized dealer
- Damage caused by improper installation
- Normal wear, maintenance, and environmental issues
- Damage caused by voltage inputs in excess of the rated maximum of the unit
- Damage inflicted during the return shipment

14. RETURN PROCESS

Before making any return attempts, it is required that you first contact B&O | Origin Acoustics. Return product to B&O | Origin Acoustics or your dealer, either in person or by mail. It's preferable if the product is returned in the original packaging. If this isn't possible, the customer is responsible for insuring the shipment for the full value of the product.

This warranty is in lieu of all other expressed or implied warranties. Some states do not allow limitations on implied warranties, so this may not apply depending on the customer's location. (For more information, see Magnuson-Moss Warranty Act.)

BANG & OLUFSEN | ORIGIN
ACOUSTICS

02-16-2024

6975 S Decatur Blvd, Las Vegas, NV 89118 • +1 844-674-4461 • docs.originacoustics.com • www.originacoustics.com • www.bang-olufsen.com
©2024 B&O | Origin Acoustics. All copyrighted, trademarked and patented elements mentioned herein are the sole property of B&O | Origin Acoustics.