

# DALI PHANTOM M WHITEPAPER



IN ADMIRATION OF MUSIC

# A LONG STORY IN SHORT

Built on experience from the award-winning and highly acclaimed DALI PHANTOM S series, DALI proudly presents a new slimline series of in-wall speakers – DALI PHANTOM M.

## DALI PHANTOM M-SERIES [Page 3]

The DALI PHANTOM M series is extremely versatile, slim and flexible in application: The DALI PHANTOM M-250 and the more advanced DALI PHANTOM M-375.

## SPACIOUS SOUND [Page 4]

The DALI PHANTOM M series provides spacious sound, regardless of whether you listen actively or passively. As with all DALI speakers, the M series offers DALI's signature wide dispersion for a room-filling sound.

## CABINET [Page 5]

Both models have the same size cabinet, measuring 250 x 775 mm, and are only 10cm in depth. The chassis is made from glass-reinforced ABS material.

## WOOFER [Page 6]

The DALI PHANTOM M-250 offers two 5¼ woofers with two bass ports in the front baffle.

The DALI PHANTOM M-375 has a larger 7" woofer with two passive radiators.

## TWEETER [Page 8]

The DALI PHANTOM M-250 has a 28mm dome tweeter, while the M-375 features a state-of-the-art hybrid tweeter.

## CROSSOVER [Page 9]

The crossover graphs illustrate that the woofers and tweeters are matched to form an optimal frequency response.

## VOICE COIL IN DETAILS [Page 10]

M-250 features a 4-layer coil with a pole piece made from a unique combination of iron and SMC.

M-375 has a larger 2-layer coil with a pole piece made of pure SMC.

## SMC IN DETAILS [Page 11]

Using SMC in DALI drivers prevents hysteresis and distortion, which gives a pure and much more pleasant expression.

## PLACEMENT OF SPEAKERS [Page 13]

The DALI PHANTOM M series is great for stereo and surround setups. The installation only requires 10cm in depth. If you want an alternative installation, it's possible to use on-wall frames.



DALI PHANTOM M-250

DALI PHANTOM M-375

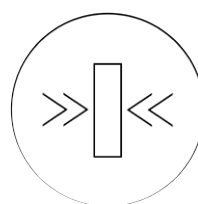

Slim

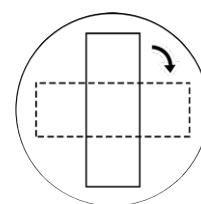

Versatile (LCR)

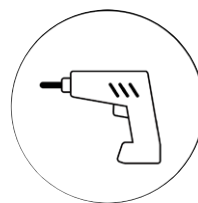

Easy installation

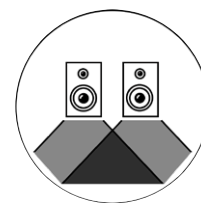

Wide Dispersion

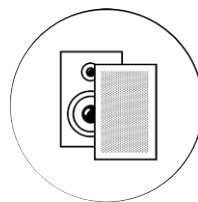

Discreet design

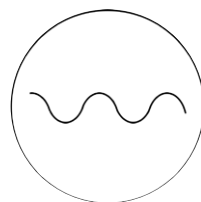

Authentic DALI sound

# DALI PHANTOM M-SERIES

You will find two models within the DALI PHANTOM M series, both extremely versatile, slim and flexible in application.

DALI PHANTOM M-250



DALI PHANTOM M-375



The series consists of the DALI PHANTOM M-250 and the more advanced DALI PHANTOM M-375.

Both models have been developed with multi-channel applications in mind, and can be mounted either vertically or horizontally. They are both equally suited for front, center or surround positioning.

Additionally, as both speakers abide by DALI's long-standing sound design principles, they will also work perfectly in a custom installed Hi-Fi stereo setup.

< 5¼" Woofer

A different approach has been taken with M-250, by utilizing two smaller active woofers, both ported and aligned with a high performance dome tweeter.

7" Woofer >

The M-375 is configured with a large active woofer and two passive radiators, coherently matched with a hybrid dome and a ribbon tweeter configuration.

< DOME TWEETER

The main difference between M-250 and M-375 is the choice of woofers and tweeters.

HYBRID TWEETER >

< 5¼" Woofer

The two DALI PHANTOM M models use the same size cabinet. This allows those who are unsure of which model to use, to make the final decision at a later stage of installation.

Lacquered black MDF on the front and glass-reinforced ABS materials on the back for optimal sound performance

# SPACIOUS SOUND

Music is listened to in either active or passive scenarios.

Active listening is when you sit in front of a speaker, focussing on the detail in the track. Passive listening takes place typically whilst socialising, where music is playing in the background to create an enjoyable atmosphere.

There is a tendency to have a single-point speaker as the main source of music in many homes, chosen for its convenience and easy fit within the interior.

A single-point speaker needs to be fairly loud in order to be heard throughout the room. During passive listening high volumes can easily become intrusive, reducing the audio experience and preventing conversation.

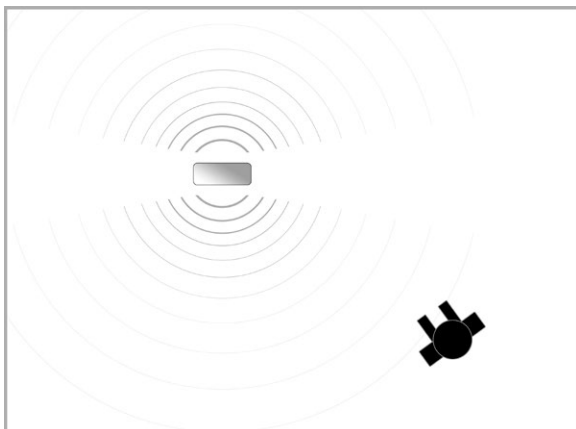

Example: A single-point speaker with blurred sound intensity, during passive listening.

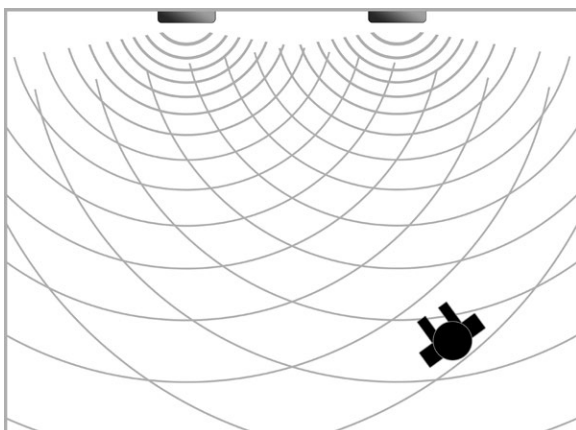

Example: Two speakers provide a stereo perspective, making the music clearer and more detailed. The improved distribution of sound means less volume is required, making it easier to have a conversation.

In comparison, a two speaker stereo set-up provides spacious, room-filling sound. This enables easier conversation, due to the speakers evenly distributing audio throughout the room.

Floorstanding speakers can be a great solution, however these may not be suitable for every home environment.

At DALI, we have set out to provide custom installation solutions with the authentic DALI sound without taking up interior space.

Following the success of the award-winning DALI PHANTOM S series, we decided to build on its legacy. The M series is the newest addition, offering spacious and detailed sound from a slim chassis.

## Wide dispersion

By specifically designing our drivers for wide dispersion they deliver a smooth and well dispersed sound, making them easy to integrate into any room.

This technology works particularly well with the DALI PHANTOM M series as they are mounted flush against the wall. Working with the off-axis optimisation creates a larger sweet spot and perfect soundstage for the listener. It also enables high quality sound from outside the sweet spot for passive listening.

By optimising the audio signal for off-axis listening, both the signal directly reaching your ear and the signal reflected from room surfaces, will have the same high quality.

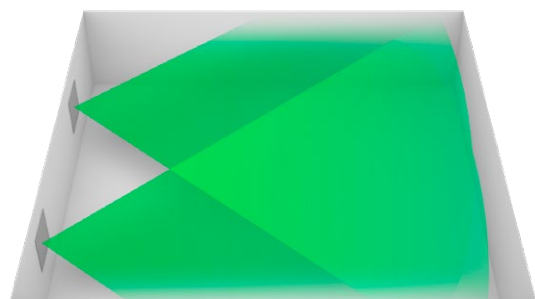

DALI's wide dispersion technology fills every corner of the room with in high quality audio and lets the listener experience the music even if not placed ideally in the sweet spot.

# CABINET

The DALI PHANTOM M-250 and the DALI PHANTOM M-375 feature the same size cabinet – 250 x 775 mm, with a depth of only 10 cm.

The cabinet is slim for an in-wall Hi-Fi speaker. The requirements for the cabinet presented our engineers with significant challenges during the development process.

The 21mm MDF front baffle and the bezel are matte black, so there are no shiny details on the front. This enables seamless integration with any home cinema, preventing any unwanted light reflecting back from the projector. The front grille is magnetic, fully paintable, and allows for a non-intrusive application.

To achieve the maximum inner volume for low frequency reproduction, within the given size limitations, the mechanical team designed a 3D Matrix Cabinet in glass-reinforced ABS compound.

Extensive design analysis and testing was applied to optimise the compound and the dimensions of the 3D Matrix housing, this enables the best acoustical working conditions.

In order to help reduce vibrations for the benefit of the high frequency reproduction, both speakers are equipped with internal bracing made from MDF.

The design of the steel chassis underwent extensive 3D computer optimization in order to ensure maximum strength in combination with minimum resonance.



On the rear of the integrated bezel you will see a gasket made of EVA rubber, effectively sealing the speaker to the wall when mounted.

The MDF front baffle is firmly mounted to the ABS cabinet.

The integrated terminals are spring-loaded for solid, durable, and easy connection – accepting up to 4.5 mm thick cable (3.0 mm AWG 12 recommended in normal situations) and 15.90 mm<sup>2</sup> max cabling.

The 6 doglegs are integrated as part of the cabinet. These are high quality manual doglegs, ensuring firm installation to avoid any rattling. They are spring-loaded for easy grip and have a reversible clamp for gripping extra thick walls – up to 70mm.

Dogleg used for attaching DALI PHANTOM M in the frame.



## WOOFER

Like all DALI drivers that are dedicated to reproducing the low frequency and delicate midrange area, the M-series woofers feature a wood fibre cone.

The DALI PHANTOM M-250 speaker is equipped with two identical active 5¼ woofers with two bass ports, whereas the DALI PHANTOM M-375 features one active 7" woofer as well as two passive radiators.

The woofers on both models use extremely light weight voice coils made of aluminium and copper. This provides dynamics and very high conductivity to handle fast changes and high level signal peaks.

Both models includes DALI's patented SMC technology in the magnet system, which minimizes hysteresis and distortion.

The wood fibre cone is a blend of a fine grain paper pulp, reinforced with wood fibres, which result in a rigid, light-weight and well-behaving structure.

In combination with a low-loss surround and spider suspension, this cone reproduces the micro dynamics of the signal - unfiltered and with high accuracy.

DALI PHANTOM M-250 WOOFER

DALI PHANTOM M-375 WOOFER

The diaphragm terminates in a rubber surround which is chosen for its soft and very flexible properties. This allows the diaphragm to move freely with a very low dampening effect, supporting the magnet motor to control the movement.

The magnet of the M-375 has a diameter of 120mm, ensuring maximum control of the driver.

The diaphragm has been perforated between the spider and the dust cap in order to improve the air flow and cooling of the magnet system due to mechanical damping forces.

This ensures better power handling and provides a more detailed sound performance.

# WOOFER

## Passive radiators

The dual 7" passive radiators in the M-375 feature a cone geometry optimised for wide dispersion and cabinet volume.

The rear surface of the passive radiator cones are loaded with small steel weights. The purpose of these weights are to tune the entire system for optimal low frequency performance.



Two bass ports on each end of the M-250; these are another way to release pressure from the cabinet, resulting in a compelling spacious and deep sound compared to the size of the cabinet.



There are two passive 7" radiators on the M-375

Whilst the DALI PHANTOM M-250 features two bass ports, the DALI PHANTOM M-375 uses the passive radiators to operate in a similar manner; mass vs. spring. The passive radiators apply physical weight instead of the air used in the M-250's bass ports.



Example of passive radiator featuring a Nomex® spider



The passive radiator does not feature a regular coated, textile spider. Instead it uses a massive spider made from Nomex® material. This does not deteriorate over time, as more conventional spiders would do in this type of driver.

The Nomex® spider is more robust and durable at high sound pressure levels – which was one of the important aims with the DALI PHANTOM M series.

## TWEETER

### Dome tweeter

The ultra-lightweight 28mm soft dome tweeter takes care of the high frequency area.

Given the size of the voice coil and diaphragm, this dome is perfect for the task. Built for maximum dynamics, great power handling and fantastic integration with midrange frequencies, this tweeter will stay on top of any sound challenge.

The oversized 28 mm membrane on the dome is based on an ultra-lightweight weave fabric. Compared to most soft dome tweeters in the market, the material of the DALI dome is less than half the weight; 0.060 mg per mm<sup>2</sup>. The relatively large-sized membrane lets the tweeter generate a higher sound pressure level with less excursion, keeping the voice coil motion to a minimum.

The in-house manufactured ultra-lightweight soft dome tweeter has been optimised for a larger bandwidth in its lower frequency area. This ensures the optimal handover from the midrange woofer to the tweeter, creating a well balanced, unforced and very coherent midrange.

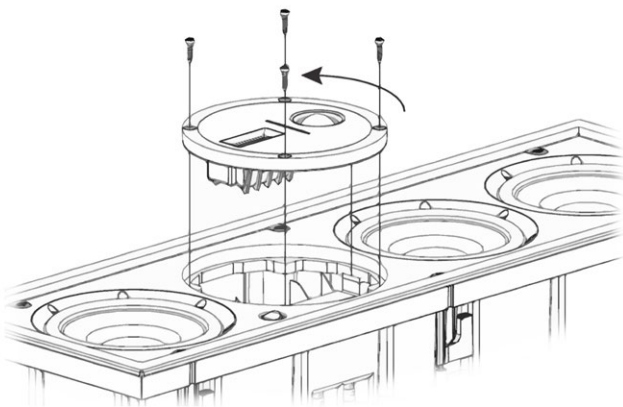

### Ribbon tweeter

The unique combination of the dome and ribbon tweeter forms the DALI hybrid tweeter used in the PHANTOM M-375. The ribbon tweeter adds extra 'air' to the tweeters performance. This is a very subtle addition which is rolled in high in the frequency range – above 10 kHz. The ribbon reaches full contribution from 14 kHz to well beyond 30 kHz, far above the audible range.

The DALI ribbon tweeter is a true master in horizontal distribution of high frequencies. It is a superb partner for the soft dome tweeter's unique ability to reproduce lower frequencies.

DALI PHANTOM M-250:  
28 mm ultra-light soft dome  
tweeter

Equipped with a rear chamber and fitted with rigid bracing, the ribbon tweeter is shielded from the disruptive influence of the woofers and passive radiators.



DALI PHANTOM M-375:  
The rotatable hybrid tweeter consists of a 28 mm  
ultra-light soft dome tweeter and ribbon tweeter.

When using the M-375 as a centre speaker, the ribbon tweeter needs to be rotated in order to maintain the wide dispersion.

To do so, the speaker is installed horizontally and the hybrid tweeter module must be unscrewed and rotated so the ribbon tweeter is vertical, ensuring wide dispersion on each side.

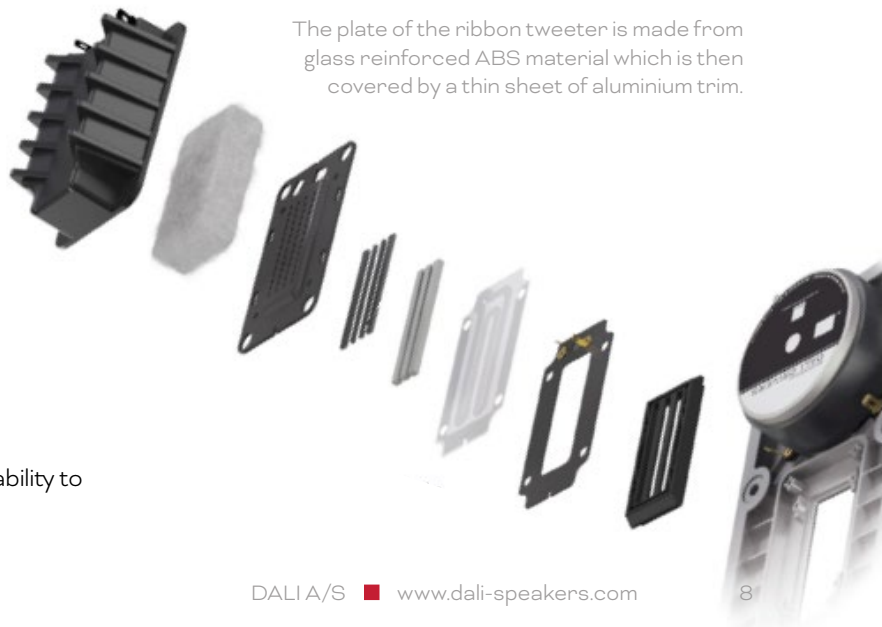

The plate of the ribbon tweeter is made from  
glass reinforced ABS material which is then  
covered by a thin sheet of aluminium trim.



# CROSSOVER

The crossovers help to avoid resonant frequencies and gaps in order to give the optimal playback. All loudspeakers from DALI use crossovers and the crossover configurations are different for each type of speaker.

This is what truly defines Hi-Fi systems from average speakers. The crossovers of the M-250 and the M-375 are much alike, but differentiated to match the respective woofer and tweeter configurations.

DALI PHANTOM M-250 CROSSOVER

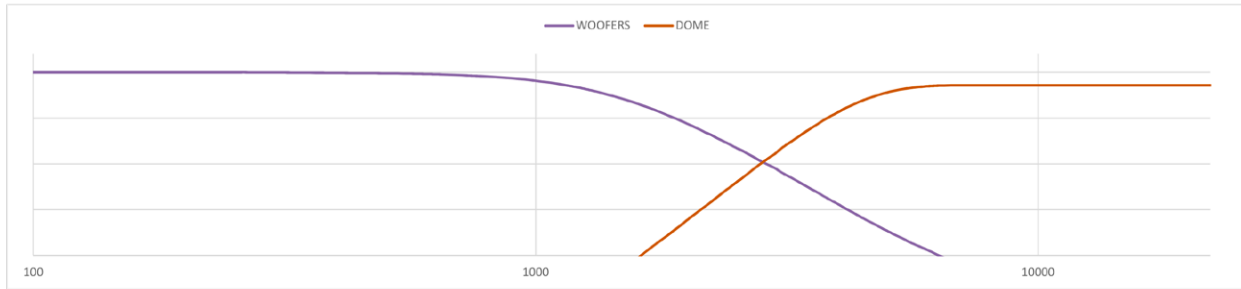

At around 2,720 hz the woofer and the dome tweeter have a crossover on the M-250. This is where the woofer starts to roll off and the tweeter kicks in.

DALI PHANTOM M-375 CROSSOVER

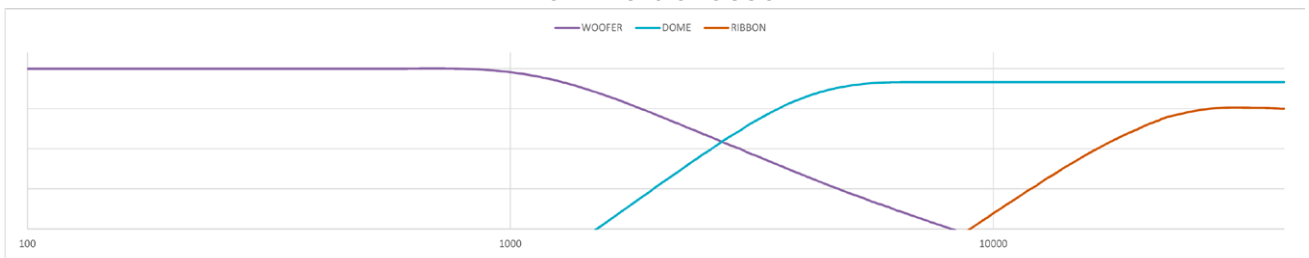

The crossover of the dome tweeter and woofer on M-375 happens at 2,500 hz and at 15,000 hz the ribbon tweeter starts supporting the dome tweeter

## Overload protection

The M-series features a PTC (Positive Temperature Coefficient) type overload protection throughout the whole system (woofer and tweeter).

The PTC will cut the signal if the volume is too loud for a prolonged amount of time, this is to prevent damage to the loudspeaker.

After the PTC protection has been activated, the protection mechanism will be somewhat more sensitive towards protecting the speakers, this will change back to normal after a few days.

The toggle switch changes the setup of the crossover, adding more treble to the sound profile. This can be used when the speakers are positioned behind an acoustically transparent video/projector screen.



## VOICE COIL IN DETAILS

### DALI PHANTOM M-250

The M-250 woofer features a 4-layer 25mm coil. While a 4-layer voice coil is effective for a high force factor, the higher moving mass will often present a challenge for the midrange response, impairing intelligibility in voice reproduction.

Our solution to minimise moving weight is a light copper clad aluminium wire. This solution applies an aluminium core and a thin-walled outer copper tube.

Combining the high conductivity/weight ratio of aluminium (205% the value of copper), with the superior resistance properties and better mechanical strength of copper -we get a lightweight voice coil with high conductivity, capable of handling high peak signal levels.

The result is seriously improved bass control, well controlled reproduction of micro details and great transient capabilities.



The pole piece on M-250 is a unique combination of iron and SMC, placing it in the main working area of the voice coil. This lowers the third order distortions.

### The polepiece

The pole piece of the M-375 magnet system applies the same amount of SMC as found in the DALI PHANTOM S series.

Two aluminium rings are used as shielding to concentrate the magnetic flux. This technology is used for lowering distortion to an absolute minimum.

### DALI PHANTOM M-375

The M-375 woofer incorporates a diaphragm similar to the highly acclaimed 8" DALI PHANTOM S woofer, but downscaled to a 7" version.

The diaphragm profile is optimised to facilitate a uniform synchronized piston movement, thereby, reducing any breakup modes across the entire cone.

The voice coil is not only inspired by the DALI PHANTOM S – it is completely identical in size to its more expensive high-end sibling.

The voice coil itself consists of copper and aluminium. A 2-layer coil with a diameter of 38mm ensures fantastic powerhandling for a driver of this size. But not only that, it also results in much less dynamic compression. As with the DALI PHANTOM M-250, the copper clad aluminium wire ensures a combination of light-weight moving mass with optimum conductivity and durability.

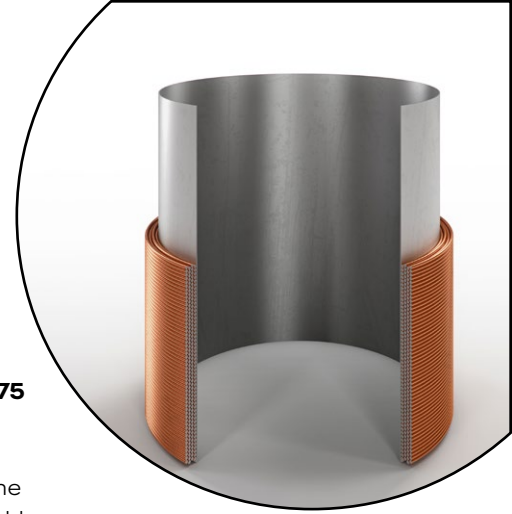

Cross section of the voice coil with 4 layers of copper

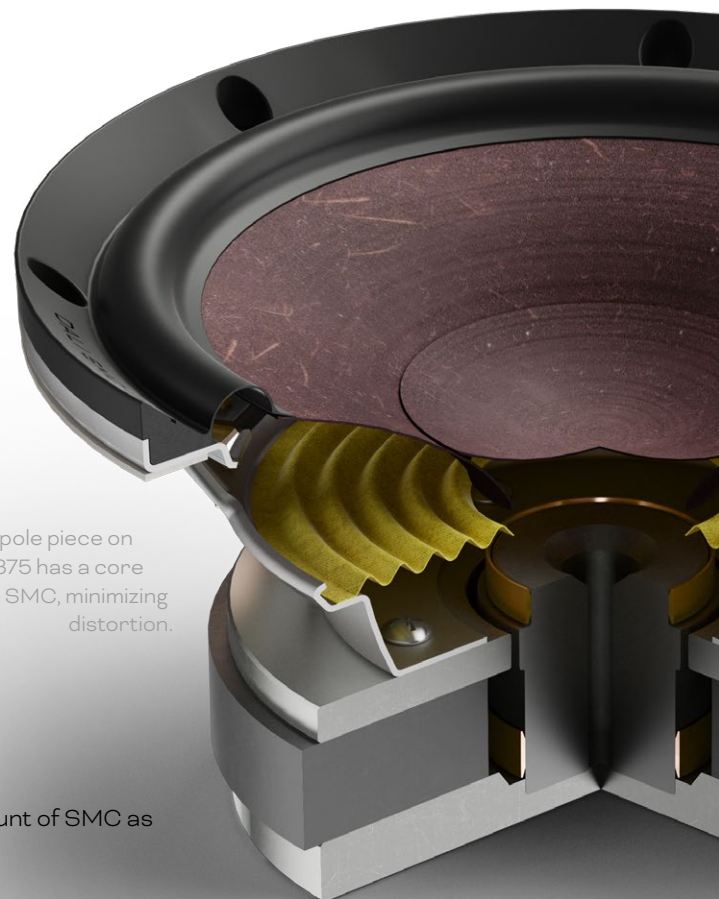

The pole piece on M-375 has a core of pure SMC, minimizing distortion.

# SMC IN DETAILS

## Low Loss Magnetism

The use of SMC (Soft Magnetic Compound) has many advantages, but the overarching result is a significant reduction of distortion from losses in the magnet motor.

SMC's unique ability to deliver a high magnetic conductivity and a very low electrical conductivity gives us all the desired qualities of a really good speaker magnet, without the traditional disadvantages.

When using iron-based magnets in speakers, the magnetisation and demagnetisation introduced by the shifting current directions, do not happen at the same pace.

The demagnetisation process is slower than the magnetisation. This phenomenon is called hysteresis, and is a known problem in almost all speaker magnet motor systems.

The problem with hysteresis is that it introduces an unintended resistance to the voice coil, resulting in unwanted distortion. The reason hysteresis occurs is because iron is not only magnetically conductive, but also very electrically conductive.

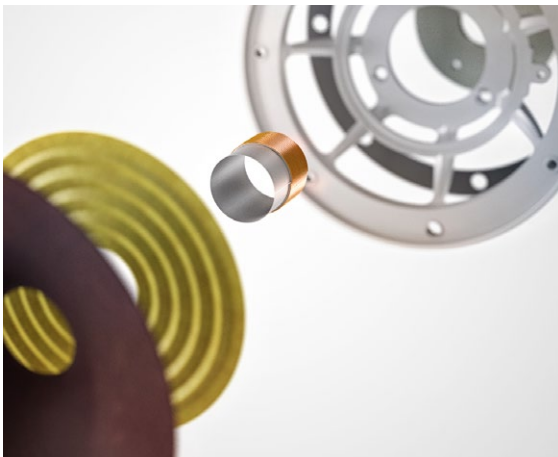

Exploded view of the voice coil used in the DALI PHANTOM M woofer

SMC on the other hand is highly magnetically conductive, but has a very low electrical conductivity (approx. 1/10,000's of iron). The result of using SMC is almost no hysteresis and no distortion.

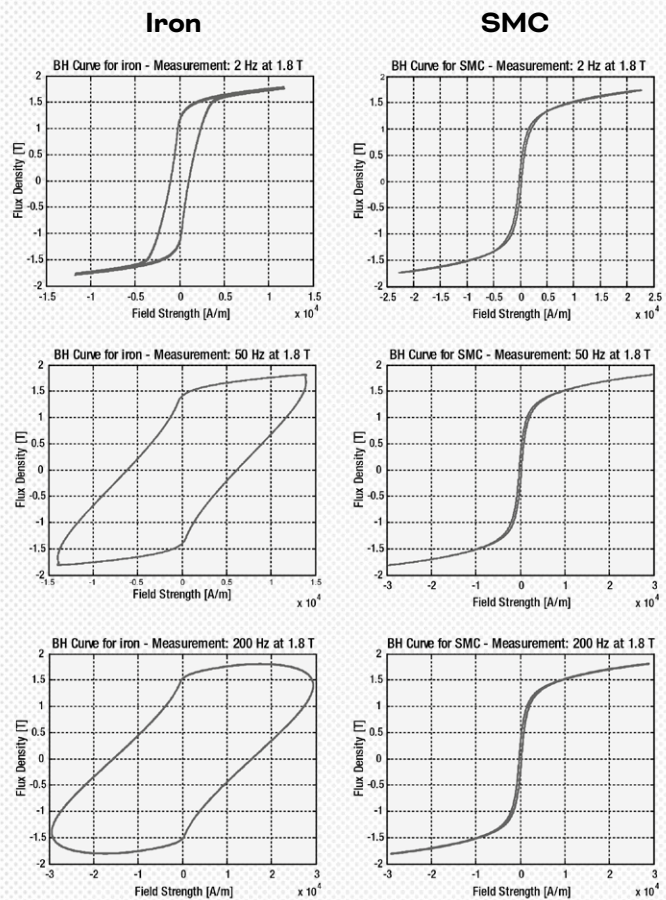

The above graphs show the hysteresis on iron based magnets in relation to SMC. There is almost no hysteresis, and therefore no distortion using SMC.

## Current linearity

In a traditional iron magnet system, the current in the voice coil will modulate the flux in the magnet gap. This flux modulation is a cause of distortion and creates a working environment for the voice coil, this is far from ideal. The modulation of the magnetic flux is caused by the iron being electrically conductive.

By introducing SMC into the area close to the magnet gap, the modulation is significantly less influenced by the current in the voice coil. As a result, we manage to greatly reduce the distortion from current-generated flux variations.



The fine grain of SMC

**Inductance Linearization**

Making our speakers amplifier-friendly is an important part of the design process. We want to make sure that it is the amplifier and not the speaker that forms the audio signal. To get the best from the amplifier, the speaker has to deliver a stable working environment.

By keeping the impedance as flat as possible across the entire frequency range, the amplifier is able to deliver the same amount of power at all frequencies. In many magnet motor designs the voice coil inductance depends on the position of the voice coil, which means the impedance varies with both frequency and level.

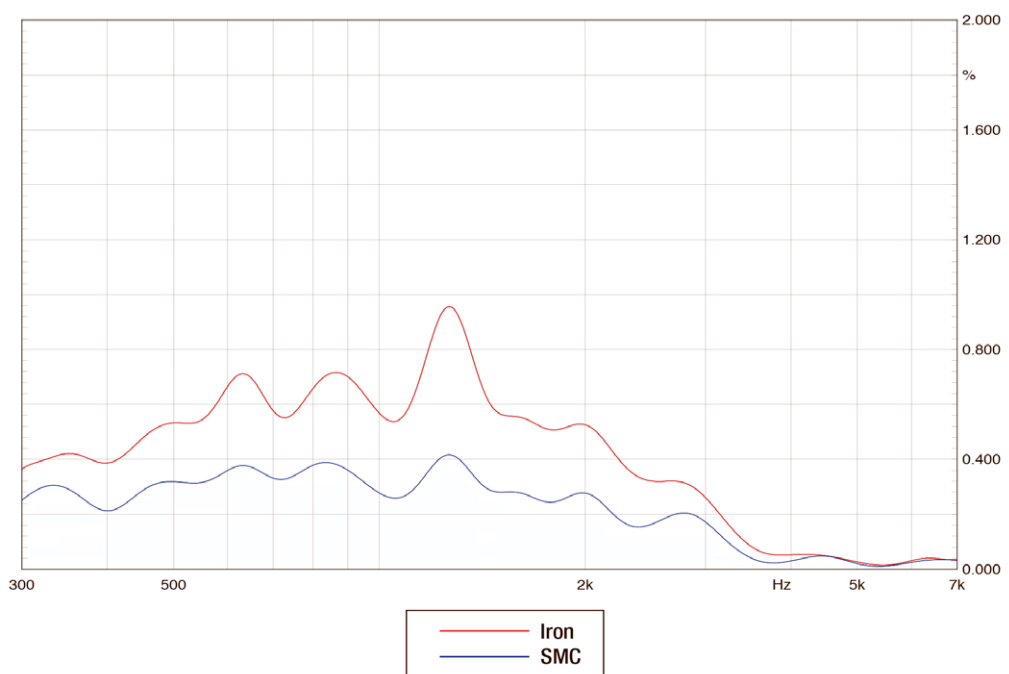

Generic example of 3rd-order distortion iron, compared to SMC.  
 This graph shows the effect on a RUBICON 8 woofer.  
 The principle of the graph is equal to other woofers with SMC.

# PLACEMENT OF SPEAKERS

For active listening, placement of the speakers can be just as important as their sound quality. The listener may need to spend time adjusting the positioning of their speakers in order to achieve the perfect setup for an optimised performance.

With both stereo and surround setups, the distance between the listener and the sound source needs to be well considered in order to optimise the speakers performance.

The cabinet is 10 cm in depth and measures 0,6 cm from the wall after being installed.



The installed frame will fit with a minor distance from the wall and with a very discreet expression when attaching the grill.

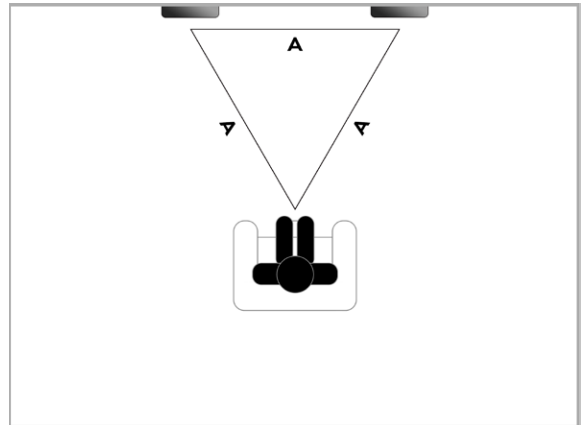

**STEREO SETUP:** The optimal setup is created by ensuring an equilateral triangle between the loudspeakers and listening position, as shown in dimensions A.

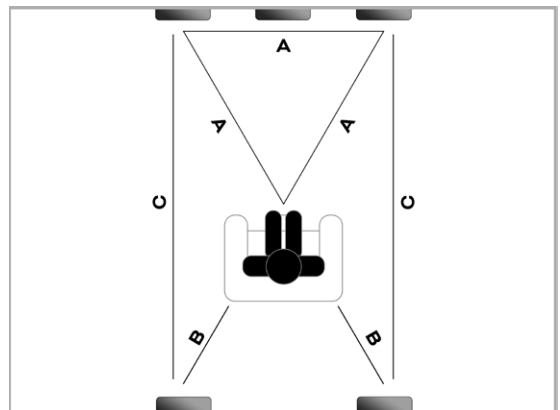

**SURROUND SETUP:** The optimal setup is created by having an equilateral triangle, as shown in dimensions A. The rear speakers should be parallel with the front speakers, shown in dimension B. Dimension C can be less than dimension A.

If you don't want to cut big holes in your wall, DALI have developed an on-wall frame, designed exclusively for DALI PHANTOM M.

These can be mounted directly onto the wall.

The ON-WALL frame is additional equipment for DALI PHANTOM M series.



## TECHNICAL SPECIFICATIONS

	DALI PHANTOM M-250	DALI PHANTOM M-375
Frequency Range (+/-3 dB) [Hz]	58 - 24,000	57 - 25,000
Sensitivity (2.83V/1m)[dB]	89	89
Nominal Impedance [ohm]	6	6
Maximum SPL [dB]	107	107
Crossover Frequency [Hz]	2,700	2,500 / 15,000
Recommended Amplifier Power [Watt]	30 - 180	30 - 180
High Frequency Driver	1 x 28 mm soft dome	1 x 28 mm soft dome 1 x 17 x 45 mm ribbon
Low Frequency Driver	2 x 5.25" Wood Fibre Cone	1 x 7" Wood Fibre Cone
Connection Input	Single Wire	Single Wire
Enclosure Type	Vented Box, 2 x port	Passive Radiator Box 2 x 7" Slave
Recommended Placement	Front/Centre/Rear/ Surround	Front/Centre/Rear/ Surround
Dimensions (H x W x D) [mm]	775 x 250 x 106	775 x 250 x 106
Dimensions (H x W x D) [inches]	30.5 x 9.8 x 4.1	30.5 x 9.8 x 4.1
Cut-out Dimensions (H x W x D) [mm]	751 x 226 x 100	751 x 226 x 100
Cut-out Dimensions (H x B) [inches]	29.6 x 8.9 x 3.9	29.6 x 8.9 x 3.9
Weight [kg/lbs]	8.45 / 18.6	8.7 / 19.2
Finish	White Lacquer Grille	White Lacquer Grille
Accessories	Manual, Cut-out Template, Allen Key bit	Manual, Cut-out Template, Allen Key bit

All technical specifications are subject to change without notice.