

Beyond Audio, **HiFi ROSE**

Top-notch Master Integrated Amplifier **RA280**



rose

Beyond Audio, **HiFi ROSE**







rose

Top-notch Master Integrated Amplifier RA280

- Class AD Amplifier with next generation GaN FET
- LC filter independently developed by HiFi ROSE
- Highly efficient and stable power supply
- Powerful 250W output
- Phono Amplifier for MM
- Control Volume for Bass/Treble

In/Out Port	Analog In	Line1, Line2, Line3, Balanced, Phono(MM)
	Analog Out	Sub Woofer
Speaker Output	Stereo	250W x 2ch (4Ω, 8Ω)

Design 430*355*110 mm / 9.5 kg / Solid Aluminum, Rust-proof Steel / Color: Black, Silver



Ultimate Network Transport RS130

- High-precision OCXO clock for Long-Term Jitter Reduction
- Fiber Optic Ethernet and Fiber Optic USB connectivity
- Network Streaming with SSD Caching Playback
- External master clock input
- Minimize electrical noise with full linear power configuration using Super capacitor

Hi-Res	DSD	Native DSD 512	In/Out Port	HDMI Out	4K
	PCM	32bit/768kHz		Network Connection	Ethernet
In/Out Port	Digital Out	OPT x 1, COAX x 1, AES/ EBU x 1, I2S-HDMI x 1	Wi-Fi		802.11ac Dualband USB Wireless LAN Card (Dongle)
	USB Audio Out	USB Type-A 2.0 (Isolation)	Bluetooth		V4.2 (USB Dongle)
	EXT. Clock Input	50Ω, 75Ω			

Connectivity Bluetooth, DLNA, Airplay, Spotify Connect, Roon Ready

Design 430*317*125 mm / 12 kg / 15.4" Wide viewing angle touch screen / Color: Black, Silver



Advanced All-In-One Network Streamer RS520

- Reference Grade All-in-One Network Streamer
- Network Streamer + DAC + Class AD Amplifier with next generation GaN FET
- High-Resolution Music Playback available(DSD512, PCM32bit/768kHz)
- A Femto Clock provides Ultra Precision
- The Special Linear Power Supply Configuration minimizes electrical noise

Hi-Res	DSD	Native DSD 512	In/Out Port	Speaker	2ch 250W(8Ω)
	PCM	32bit/768kHz		USB Audio In	USB B Type 2.0
In/Out Port	Digital In	Optical, Coaxial, eARC	Network Connection	USB Audio Out	USB A Type 3.0
	Digital Out	Optical, Coaxial		Amp	250W + 250W @ 8Ω, 4Ω
	Analog In	Line In		Ethernet	10/100/1000 BASE-T
	Analog Out	Pre-out_RCA		Wi-Fi	Optional_dongle (2.4GHz/5GHz)
	HDMI Out	4K		Bluetooth	Optional_dongle

Connectivity Bluetooth, DLNA, Airplay, Spotify Connect, Roon Ready

Design 346*328*127 mm / 8.1 kg / 12.6" Wide viewing angle touch screen / Color: Black, Silver



Integrated Amplifier - With Gallium Nitride Amplifier built in RA180

- Class AD Amplifier with next generation GaN FET
- Multi Output Component
- Designed to play up to the Super Twitter Realm
- Balanced Power Supply
- Phono Amplifier with Variable EQ

In/Out Port	Analog In	Line1, Line2, Line3(Bypass), Balanced, Phono(MM/MC)
	Analog Out	Sub Woofer
Speaker	Stereo(A/B)	4ch 200W(8Ω)
	Stereo(A), BTL(B)	Stereo(A): 4ch 200W(8Ω) / BTL(B) : 2ch 400W(8Ω)
	BTL(A/B)	BTL(A) : 2ch 400W(8Ω) / BTL(B) : 2ch 400W(8Ω)

Design 430*391*124 mm / 16.7 kg / Solid Aluminum, Rust-proof Steel / Color: Silver



High Performance Network Streamer RS150 Series

- Flagship Network Streamer
- Network Streamer + DAC
- High-tech DAC design for pure sound with low noise and low distortion
- High-Resolution Music Playback available(DSD512, PCM32bit/768kHz)
- A Femto Clock provides Ultra Precision
- The Special Linear Power Supply Configuration minimizes electrical noise

Hi-Res	DSD	Native DSD 512	In/Out Port	HDMI Out	4K
	PCM	32bit/768kHz		USB Audio In	USB B Type 2.0
In/Out Port	Digital In	Optical, Coaxial, AES/EBU, HDMI ARC, USB Audio	Network Connection	USB Audio Out	USB A Type 3.0
	Digital Out	Optical, Coaxial, AES/EBU, I2S-DVI, I2S-RJ45		Ethernet	10/100/1000 BASE-T
	Analog In	Line In		Wi-Fi	Optional_dongle
	Analog Out	Pre-out_XLR, Pre-out_RCA		Bluetooth	Optional_dongle

Connectivity Bluetooth, DLNA, Airplay, Spotify Connect, Roon Ready

Design 430*318*124 mm / 11 kg / 14.9" Wide viewing angle touch screen / Color: Black, Silver



Complete HiFi Network Streamer RS250A

- Reference Grade All-in-One Network Streamer
- Network Streamer + DAC
- High-Resolution Music Playback available(DSD512, PCM32bit/768kHz)
- A Femto Clock provides Ultra Precision
- The Special Linear Power Supply Configuration minimizes electrical noise

Hi-Res	DSD	Native DSD 512	In/Out Port	Headphone Out	3.5mm
	PCM	32bit/768kHz		USB Audio In	USB B Type 2.0
In/Out Port	Digital In	Optical, Coaxial	Network Connection	USB Audio Out	USB A Type 3.0
	Digital Out	Optical, Coaxial		Ethernet	10/100/1000 BASE-T
	Analog In	Line In		Wi-Fi	802.11 a/b/g/n/ac (2.4GHz/5GHz)
	Analog Out	Pre-out_RCA		Bluetooth	V4.0 / V3.0+HS
	HDMI Out	4K			

Connectivity Bluetooth, DLNA, Airplay, Spotify Connect, Roon Ready

Design 278*231*83 mm / 3.2 kg / 8.8" Wide viewing angle touch screen / Color: Black, Silver



HiFi Network Streamer RS201 Series

- Reference Grade All-in-One Network Streamer
- Network Streamer + DAC + AMP
- Built-in High-Performance Power Amplifier(50W*2ch)
- High-Resolution Music Playback available(DSD256, PCM32bit/384kHz)
- A Femto Clock provides High Precision
- Digital equipment, PreAmplifier connection available
- Awarded the world's three major design awards(Reddot, GOOD DESIGN, PIN-UP)

Hi-Res	DSD	Native DSD 256	In/Out Port	Headphone Out	3.5mm
	PCM	32bit/384kHz		USB Out	USB A Type 3.0 / 2.0
In/Out Port	Digital In	Optical	AMP	AMP	50W X 2CH(4Ω)
	Digital Out	Optical		Ethernet	10/100/1000 BASE-T
	Analog In	Line In	Network Connection	Wi-Fi	802.11 a/b/g/n/ac (2.4GHz/5GHz)
	Analog Out	Pre-out_RCA		Bluetooth	V4.0 / V3.0+HS
	HDMI Out	4K			

Connectivity Bluetooth, DLNA, Airplay, Spotify Connect, Roon Ready

Design 278*231*85 mm / 2.3 kg / 8.8" Wide viewing angle touch screen / Color: Silver



HiFi Media Player RS301

- High-end All-in-One Speaker
- Network Streamer + DAC + AMP + SPEAKER
- 3-Way full-range speaker configuration
- High-Resolution Music Playback available(DSD256, PCM32bit/384kHz)
- Powerful sound playback with dual passive woofer engine design(Patented technology)
- Awarded the world's three major design awards(Reddot, PIN-UP, iF)

Connectivity Ethernet, Wi-Fi, Bluetooth, DLNA, Airplay

Rear Micro USB, USB A Type, USB B Type, Micro SD, Headphone, AUX

Design 360*122*119 mm / 1.9 kg / 5" IPS touch panel / Color: Silver



Premium Media Player RS350

- Casual All-in-One Speaker
- Network Streamer + DAC + AMP + SPEAKER
- 3-Way full-range speaker configuration
- Playback of various file formats available(Music, Video, Image)
- Powerful sound playback with dual passive woofer engine design(Patented technology)

Connectivity Wi-Fi, Bluetooth, DLNA, Airplay

Rear Micro USB, USB A Type, Micro SD, Headphone

Design 364*123*123 mm / 1.5 kg / 5" IPS touch panel / Color: White



HiFi ROSE USB Fiber Optical Hub RSA720

- Compact Design Maximizing Usability and Functionality
- Adopted an Optical USB Port
- Supports USB 3.0/2.0 via Four Independent USB Ports
- Guaranteed Stable Data Transmission Speed
- Long-Distance Transmission Available

Input USB 3.0 B-Type, SFP(10G)

Output USB 3.0-2ports, USB 2.0-2ports

Design 152*153.5*33.5 mm / 1.2 kg / Color: Silver



HiFi ROSE CD Drive RSA780 Series

- USB-isolator Adopted to block motion noise
- USB-B Type Port Adopted for HiFi Audio
- 900g weight for CD playback without external shaking
- Minimized Motion Noise by applying Insulators
- Provides CD Ripping Features

Rear USB B Type

Design 152*152*25 mm / 0.9 kg / Color: Silver



Innovative ROSE OS System



Spotify Connect

Spotify Connect allows you to play and wirelessly control Spotify music on your ROSE OS over a network. With the Spotify Connect function, you can enjoy a variety of music with HiFi sound quality on your ROSE device.



TIDAL

Enjoy music streaming and videos with TIDAL's unique features. Supports MQA Full Decoder, so you can enjoy high-resolution music.



Qobuz

Enjoy music streaming with Qobuz's various functions. Support for Hi-Res Audio(24bit/192kHz) means you can enjoy high-resolution music.



Roon Ready

ROSE OS is fully compatible with Roon Core, with Roon Ready certification in compliance with all requirements of Roon Labs. You can enjoy HiFi sound quality on your ROSE device with the powerful music management capabilities of Roon.



Bugs

Listen to high-resolution music on Bugs. Easily connects existing functions, including login, playlists, and playback.



ROSE Podcast

Listen to various podcasts from around the world.



Clock

Various design clock functions are provided, such as alarms and weather information.



Apple Music App

Enjoy curated playlists divided by Apple Music's own musical tastes. You can enjoy various tracks in Apple Music.



Hi-Res Audio

HiFi ROSE devices are certified with a 'High-Resolution Audio' license from the JAS (Japan Audio Society).



4K Video

You can enjoy high-definition videos on YouTube, TIDAL, and Bugs, and play video files in various formats.



MQA

Supports MQA's Full Decoder. Enjoy studio mastering sound quality.



ROSE Radio

Enjoy Rose Radio, which consists of about 30,000 radio channels from 200 countries around the world. Channels are organized into various categories, and you can easily search for channels with filters of genre/region/language.



ROSE Tube

You can enjoy all content and music on YouTube.



CD Player

Play CDs by connecting an external USB CD-ROM.



CD Ripping

Rip CDs by connecting an external USB CD-ROM and save them on a storage device.



File Manager

You can perform file and folder management tasks, such as moving, copying, and deleting, on storage device.



Music Library

Manage your music files under various categories, such as albums, artists, and genres.



My Playlist

Create your own playlist. You can also register your friends and share it with them.

ROSE Connect Remote Application

A dedicated Remote App is provided that allows users to conveniently control and smartly manage their ROSE device. The Remote App is supported on various platforms, including the iPhone, iPad, Android phone, and PCs.

Control

You can freely and conveniently control various HiFi ROSE functions wirelessly.

Control You can control a variety of functions remotely including Music, ROSE Tube, TIDAL, Qobuz, Bugs, Radio, Podcasts, Apple Music and CD Ripping.

Remote ROSE Connect includes the remote control function.

Search You can conveniently search for a variety of music in the Media Library.

Streaming

You can simply and easily play music stored on your phone on your ROSE device. Enjoy a lossless, high-quality streaming service.

Playlist

You can create your own playlist.

Make a playlist on Music and ROSE Tube and check it out at Home - My Music.

Share with Friends

You can share your playlists with your friends or listen to music recommended by them. Communicate with your friends through music.

Media Library

Scan the music in your local memory to organize it into various categories.

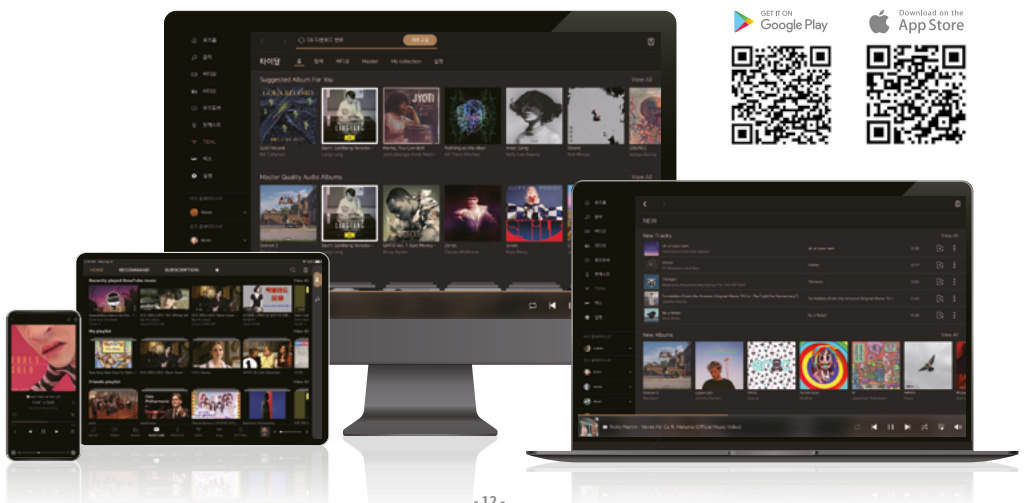

OWNER'S MANUAL

RA280 Product User Manual

Table of Contents

Safety Precautions	16
1. Warnings	16
2. Precautions	16
Components List	17
Location / Function of Buttons and Ports	18
1. Front Side of the Product	18
2. Rear Side of the Product	19
3. Remote Control	20
How to Install the Product	21
1. Product Design Method and Recommended Installation Location	21
2. How to Connect the Power Cord	22
3. How to Properly Connect the Rear Ports and Cables	23
3-1. Connecting the Analog Input Port to the Source Device	23
3-2. Connecting the Phono(MM) Input Port to an Audio Device	24
3-3. Sub Woofer Output	24
3-4. Trigger Input Terminal and Pin out	25
4. Mobile Wi-Fi Settings	26
4-1. Mobile Wi-Fi Setting	26
4-2. IP Connection Screen	27
4-3. Device Registration	27
4-4. Amplifier Search Screen	32
4-5. Amplifier Control Screen	33
4-6. Amplifier Status Information Check	34
Product Specifications	39
1. Specifications	39
Appendix	40
1. Bass Control Function of the Preamplifier	40
2. Treble Control Function of the Preamplifier	41
3. Phono Equalizer Curve	42
Quality Guaranteed	44



rose

Safety Precautions

1. Warnings

- Do not apply excessive force to the product, throw it, or strike it with sharp objects.
- When children use the product, parents must instruct them on how to use it correctly and make sure they do so.
- Use within a temperature range of 0 °C - 40 °C and do not use in hot or humid conditions. Install the product in a well-ventilated area, not an enclosed space, as product failure, corrosion, heat, or ignition may occur in an environment below 0 °C or in a sealed environment with a high temperature, such as a dry sauna. Moisture or liquid can also damage the surface of the product and its circuit components.
- Be sure to use a genuine power cable provided by ROSE. Any other cable may cause operational errors or damage (degradation of performance) to the product.
- Do not spill dirt or liquid on the product. It may damage the components and circuits. If the product gets wet, do not turn it on. Contact your nearest service center. However, free repairs are not available in this case.
- Do not connect accessories not guaranteed by ROSE to the product, and do not place the product on any object that may interfere with radio waves (metal desk, microwave, etc)
- Because the product is sensitive to radio waves, using it near steel or electromagnetic devices can lead to poor performance.

2. Precautions

- The contents of the owner's manual are described based on the default settings of the product.
- This product may be changed without prior notice to the user in order to improve product performance.
- The features and additional services of the product may vary depending on the country, software specifications, and policy changes of the service provider.
- The Wi-Fi connection may be slow due to signal interference.
- Do not use chemical solutions (alcohol, thinners, solvents, etc) or detergent to clean the product. Rubbing the product with a chemical solution can create heat and cause the product to catch fire. When cleaning the product, wipe it with a soft cloth or dry towel.
- Do not disassemble, modify or repair the product on your own. If you do, you will no longer qualify for free repairs. If a malfunction occurs because of this, contact an authorized service center for repairs.
- Install the product close to an outlet so that it is easy to remove the plug from the outlet.
- To completely disconnect the product from the AC main power source, unplug the power supply cord from the AC outlet.
- Do not use the product near water. Do not expose the product to a dripping or splashing environment and do not place objects containing liquids, such as vases, on the device.
- Do not block the ventilation openings. Install this product according to the product installation and orientation instructions.
- Unplug the product during lightning storms or when unused for long periods of time.
- **Precautions for Child Protection**
 - If one of the coin batteries inside the remote control is swallowed, it may cause serious burns or death within two hours.
 - Store new and used batteries out of the reach of children.

⚠ Caution

• Precautions for High-Temperature Parts During Set Operation

- These parts are for discharging the high temperature inside the set to the outside, and they may cause burns during the set operation. Be sure to turn off the power and wait for 30 minutes.
- Never cover the top of the main body, including the ventilation openings, with cloth and always leave them open.

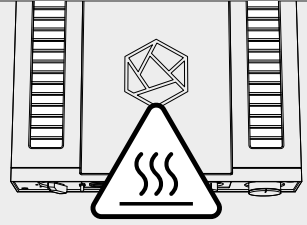



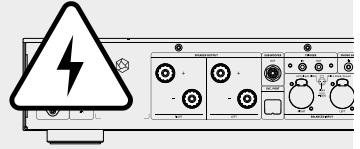

⚠ Caution

• Precautions for Electric Shock Caused by the Set

- When the volume is high, the speaker output is high, and high voltage and high current power flows. Be sure to turn off the power when touching or connecting.
- Do not touch with wet hands while the power is on.

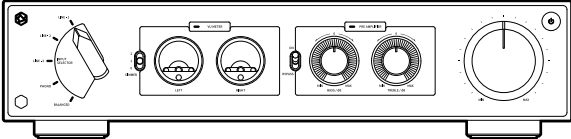

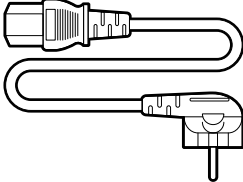
Components List

1	Main Device	
2	Remote Control (including battery)	
3	Power Cable	
4	User Manual	

Location / Function of Buttons and Ports

1. Front Side of the Product

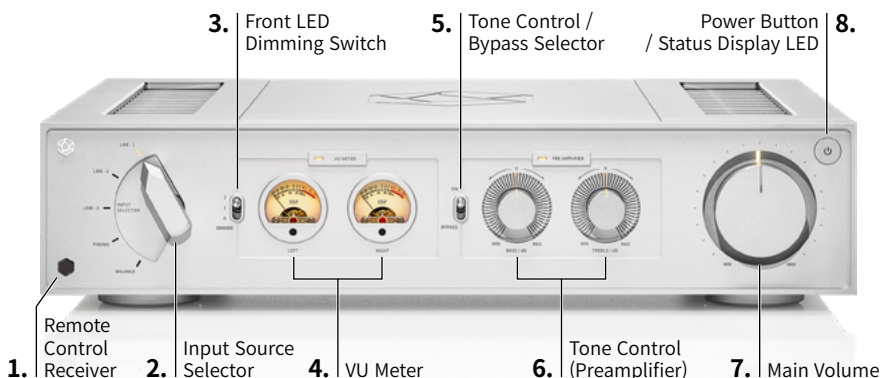

1	Remote Control Receiver	This is the optic receiver part that receives infrared signals from the remote control.
2	Input Source Selector	Selects the input of devices such as DACs, CD players, and tuners connected to each input on the rear side. The input selector is compatible with a total of five external inputs: three line inputs, one balanced input, and one phono input. It is also driven by an electric motor, so it can be controlled remotely.
3	Front LED Dimming Switch	Adjusts the brightness of the light on the front of the product in 3 steps.
4	VU Meter (Volume Unit Meter)	Displays the level of the sound source signal in real time.
5	Tone Control / Bypass Selector	Selects the tone control function and bypass function. ※ When the selector is set to BYPASS, the bass and treble knobs other than the balance switch do not work.
6	Tone Control (Pre Amplifier)	BASS : Controls the frequency characteristics of the low frequency range. When the knob is set to the center position, a flat frequency characteristic is obtained. Turning clockwise increases the level of the low-frequency band, and turning counterclockwise decreases the level of the low-frequency band. TREBLE : Controls the frequency characteristics of the high frequency range. When the knob is set to the center position, a flat frequency characteristic is obtained. Turning clockwise increases the level of the high-frequency band, and turning counterclockwise decreases the level of the high-frequency band. ※ Please refer to pages 37 - 38 for detailed tone control characteristic curves.
7	Main Volume	The main volume is powered by an electric motor and can be adjusted remotely. (via remote control or the mobile app).
8	Power Button (Status Display LED)	When the power button is pressed, the LED blinks, and when booting is complete, the LED turns off. ※ If there is no input signal for a certain period of time, the product automatically turns off. If it is turned off automatically, turn it on again with the power button on the main body or the power button on the remote control to use it. (You can set the time in the automatic power off (APO) function of the mobile app)

2. Rear Side of the Product

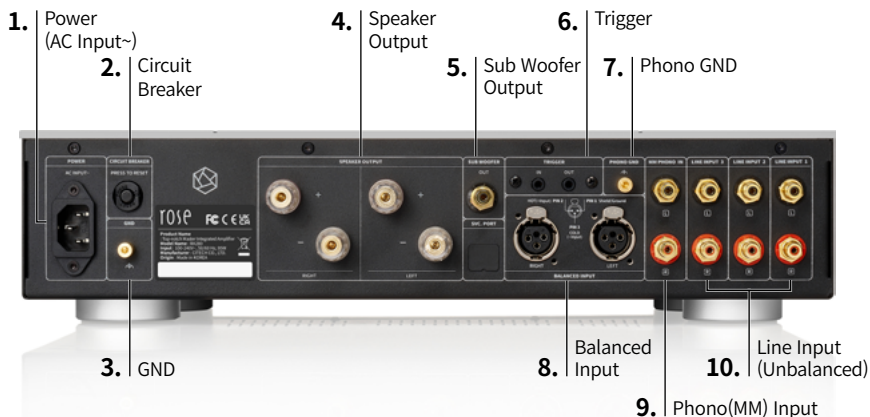

1	Power (AC Input~)	This is the power input terminal connected to the AC power cable.
2	Circuit Breaker	This is an electronic fuse that prevents damage to the set due to overvoltage or overcurrent. If the power is cut off due to overcurrent, press the button to restore it.
3	GND	This port is used to ground the product and external devices.
4	Speaker Output	It is composed of 2CH stereo and outputs 250W(4Ω, 8Ω) for each channel.
5	Sub Woofer Output	This provides a rich low-pitched listening environment by connecting with an active sub woofer unit. ※ Only active subwoofers (with separate built-in amplifiers) are compatible.
6	Trigger	In This is a function that automatically turns on the set without operation through the remote control when DC 3.3 - 12 V power is supplied from an external device. ※ It will be switched back on when the trigger input for this set is powered off with power applied. Be sure to turn off the power of the external device as well.
		Out When you press the power on button on the set, a DC 12V power control signal is output to the trigger out terminal after the power is stabilized. This function is for synchronizing power with external devices.
7	Phono GND	When connecting the turntable, connect the ground line to reduce noise.
8	Balanced Input	This is a port that receives a balanced input (XLR) from an external source device, and the input sensitivity is 600mV.
9	Phono(MM) Input	This is a port that receives RCA input from an external turntable device, and the input sensitivity is 5 mV. ※ A phono amplifier is a device that receives low-level phono signals and outputs signals at high output, so it is greatly affected by signals from surrounding external devices. Therefore, it is recommended that router devices such as Wi-Fi routers be kept at least 3m away from this product.
10	Line Input (Unbalanced)	This is a port that receives RCA input from an external source device, and the input sensitivity is 300mV.

3. Remote Control

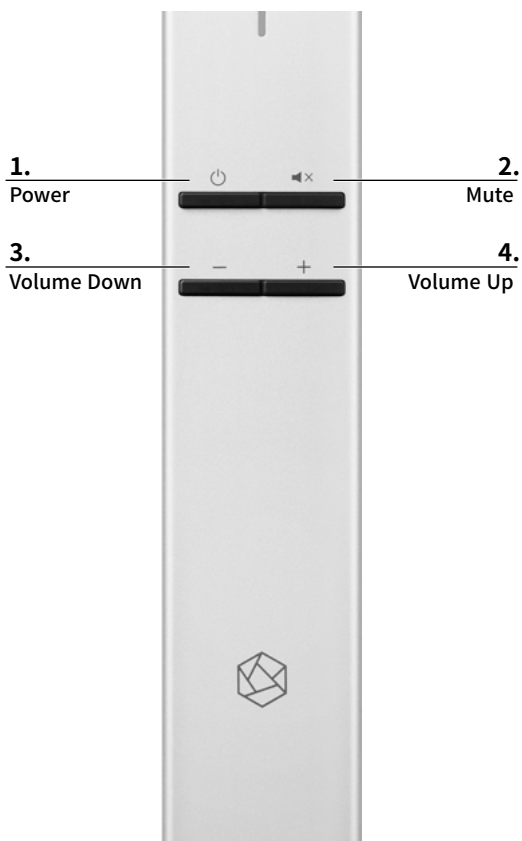

1	Power	Used to power the set on or off.
2	Mute	Used to mute music.
3	Volume Down	Used to decrease the volume.
4	Volume Up	Used to increase the volume.

How to install the Product

1. Product Design Method and Recommended Installation

- This product is designed to be used on a table or shelf.
- This product can malfunction during cold weather or hot weather.
(Operating temperature: 0 to 40°C, Storage temperature: -10 to 50°C)
- If the space where the product is installed is small, provide adequate ventilation for the product. A longer operating life is ensured when electronics are properly ventilated and maintained so that they do not overheat more than necessary. Do not install this product directly on a device that generates a lot of heat, such as a power amplifier.
- The figure below shows the minimum ventilation requirements required for the product.
- Keep at least 25mm apart on each side of this product to prevent airflow from clogging.
- Secure a depth of 40cm for airflow and cabling.

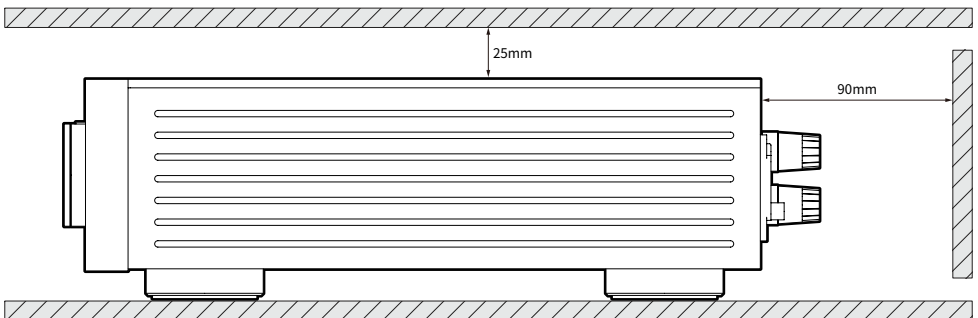
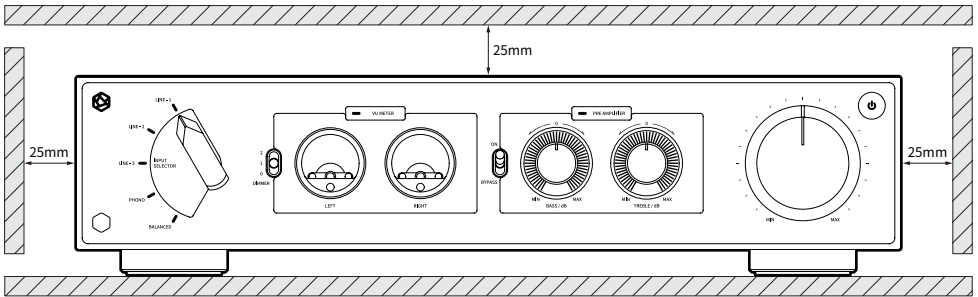

2. How to Connect the Power Cord

- This product includes a removable power cord. Please connect the power cord after connecting all audio cables.

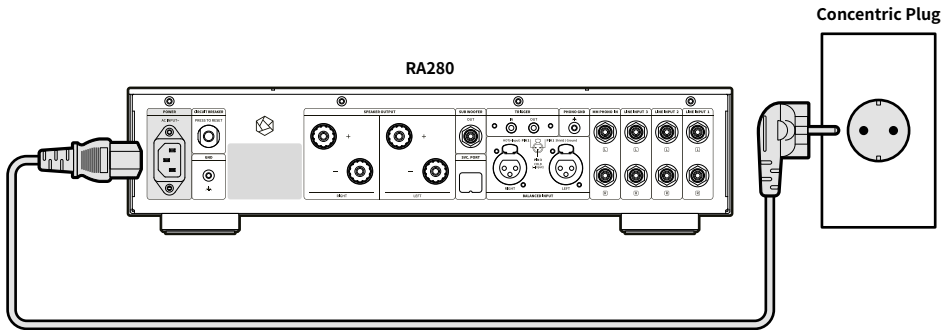

- ⚠ **Caution** : When disconnecting the power cord, always disconnect the power outlet first with the power switch off.
The non-operating voltage range is 140 - 179 V (Blank rating).

3. How to Properly Connect the Rear Ports and Cables

3-1. Connecting the Analog Input Port to the Source Device

- As shown in the figure below, you can connect the analog output port of the source device to the analog audio input(Balanced/Line 1, 2, 3) of this product.
- For the analog audio input sensitivity of Lines 1, 2, and 3 this product, export a maximum output of stereo 250W(4Ω, 8Ω) at up to 300mVrms(-8.239 dBu).
- For the balanced analog audio input sensitivity of this product, export a maximum output of stereo 250W(4Ω, 8Ω) at up to 600mVrms(-2.218 dBu).
- After connecting the cables, connect the power cable. There may be a risk of electric shock.

⚠ Caution : Before connecting this product to a source device, set the volume of the product to mute or below level 5, and then connect it using an RCA cable.

If you connect the cable while the volume of the product is turned up, a loud shock noise may occur.

- The XLR jack connection configuration polarity is shown below.

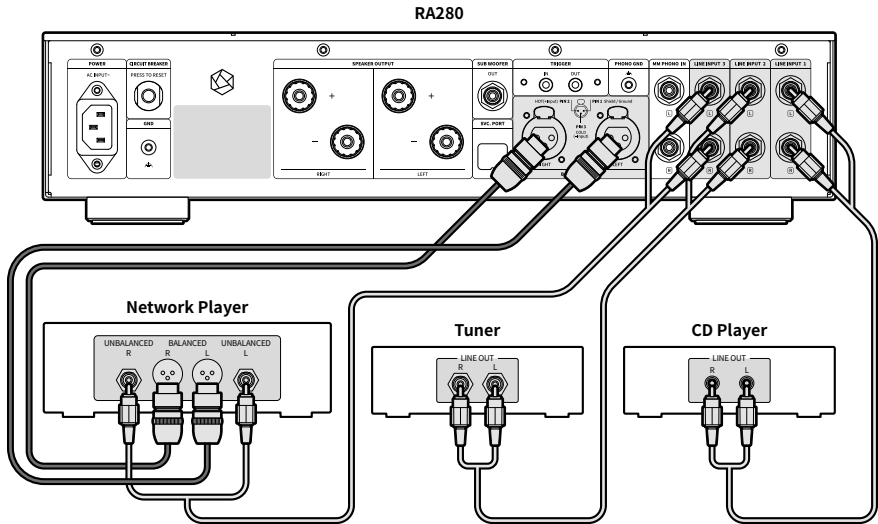
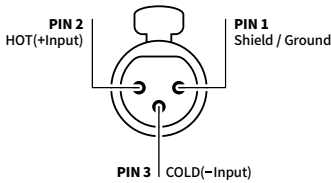

3-2. Connecting the Phono(MM) Input Port to an Audio Device

- You can connect the analog output of the turntable to the phono analog audio input (PHONO IN) of this unit, as shown in the following figure.
 - When using the phono audio input as the source, you need to switch the input source to “PHONO” in the input settings. Input settings can be changed by remote control or manually.
 - The input sensitivity is 5mV (-43dBu), and the maximum output is 250W(4Ω, 8Ω) for stereo.
 - If the input source of this product is set to “PHONO” and the volume is suddenly increased without a turntable connected, a humming noise may be heard from the speaker.
- ※ The phono GND (signal GND) terminal on the rear side of this product cannot be used for power grounding. When a lot of noise is generated, you can reduce the noise by connecting this GND terminal to the signal GND of an external phono device.
- ※ Conversely, connecting some turntables to the signal GND terminal may increase noise, which may be counterproductive. In this case, please remove the signal GND connection line between devices.

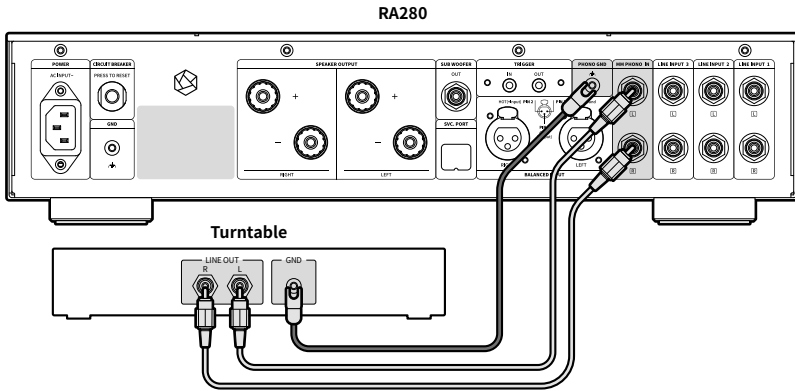

3-3. Sub Woofer Output

- As shown in the figure below, you can connect an active sub woofer device to the subwoofer analog audio output of this product.
- The subwoofer output level of this product is up to 1 Vrms (2.218 dBu).

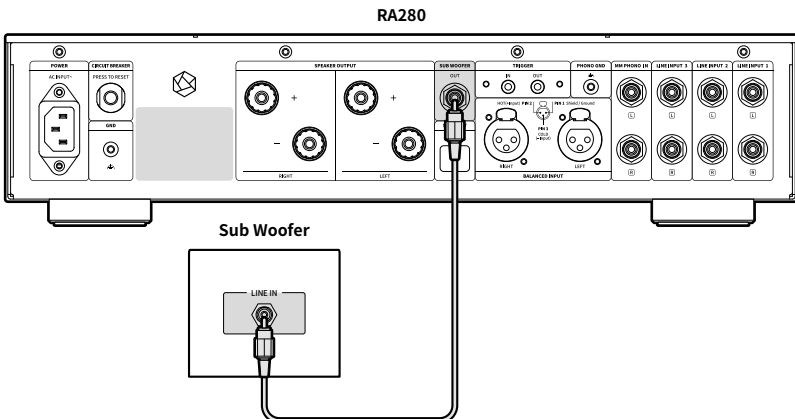

3-4. Trigger Input Terminal and Pin out

- The trigger function can control the power by linking the product and the source device.
- If you are using a source device with a trigger output terminal, you can use it as a trigger function to control the power on and off by connecting it to the trigger input terminal of the product with a monaural mini-plug cable.

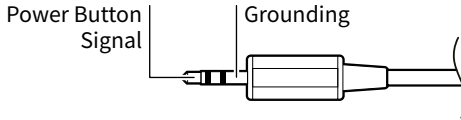

Trigger Input Voltage : DC 3.3V ~ DC 12V

Trigger Output Voltage : DC 12V

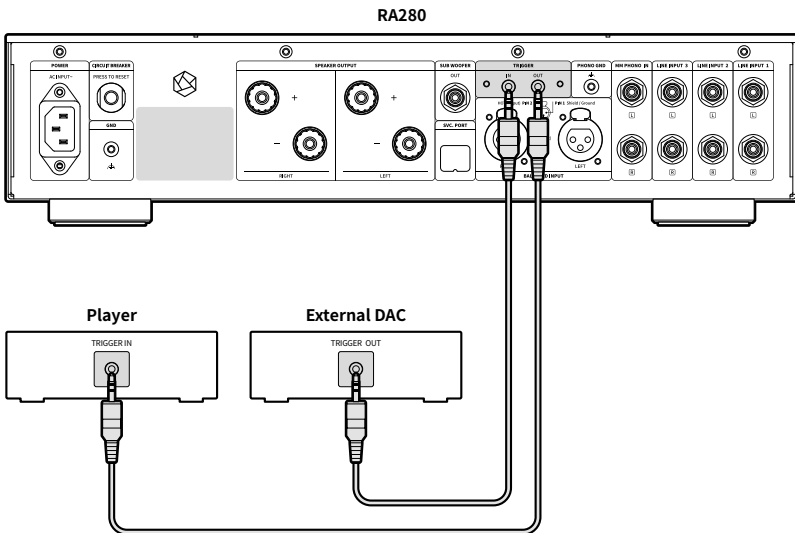

4. Mobile Wi-Fi Setting

4-1-1. Search Screen

This is the screen that appears when you run AMP connect for the first time. You can search for amplifiers connected to the Wi-Fi network to which the device is currently connected.



4-1-2. Search Screen (No Search Results)

If there is no amplifier connected to the Wi-Fi network that the device is currently connected to, a message saying that no amplifier was found will appear.

- You can search for the amplifier again by tapping the Refresh button at the top right.
- You can use the IP address connection function by tapping the IP Connection button.
- You can use the device registration function through Device Registration.

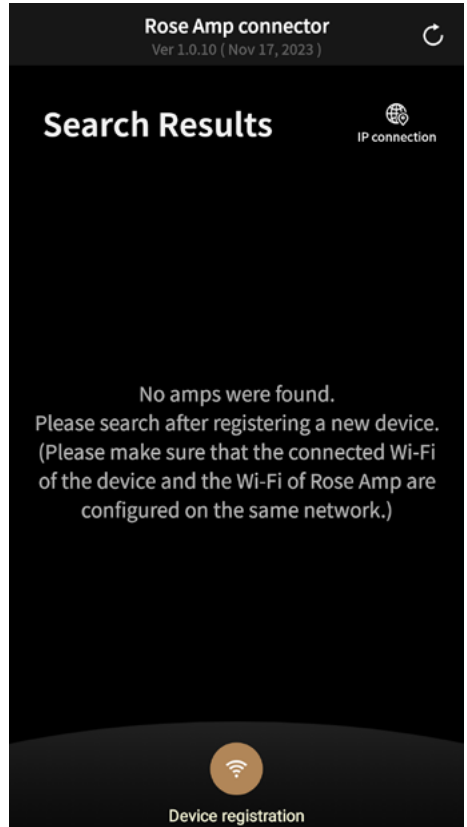

4-2. IP Connection Screen

You can use the app by directly entering and registering the IP address to which the amplifier is connected by tapping the IP Connection button.



4-3. Device Registration

• Amplifier Connection Standby Status Information Screen

When you turn on the power of the amplifier to be connected and press and release the Power button for five seconds, the backlight LED around the volume blinks and the amplifier enters the connection standby state. The amplifier appears in the Wi-Fi list as ROSEAMP_XXXXXX.

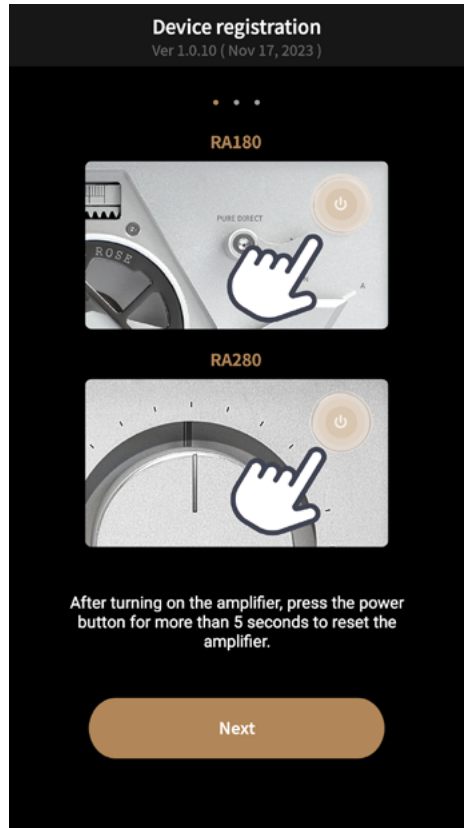

4-3-1. Device Amplifier Connection Information Screen

This is the device registration information screen. Please read the instructions carefully and pay attention to the screen.

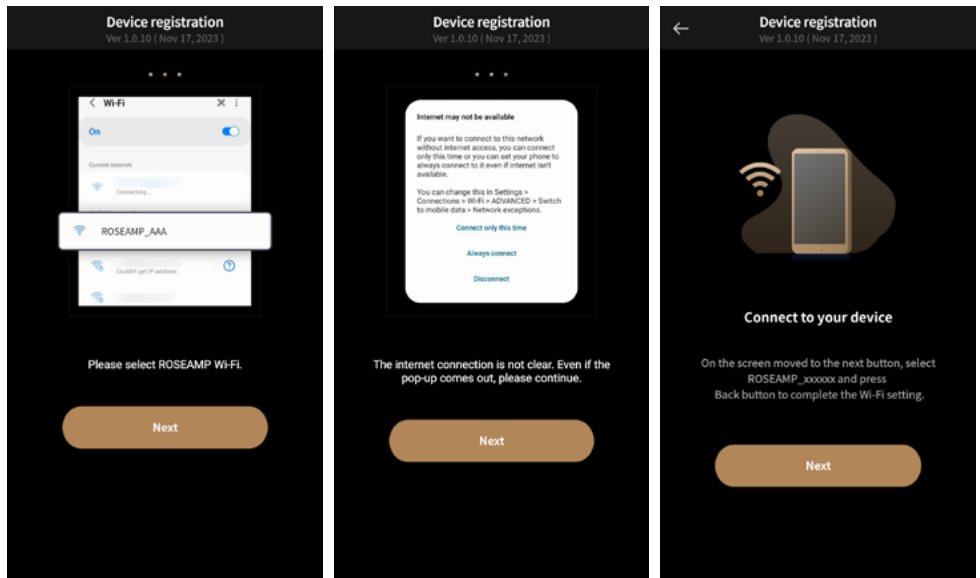

4-3-2. Amplifier Registration Screen

When you press the Next button on the last screen of 4-3-1, you will see the name of your amplifier labeled ROSEAMP_XXXXXX in the Wi-Fi list. When you select this amplifier, the status will change to 'Connected'.

Afterwards, when you press the Back button on the device to return to the AMP Connect app, the status information in the center changes to 'Connect' and becomes activated. Please tap the activated Connect button.

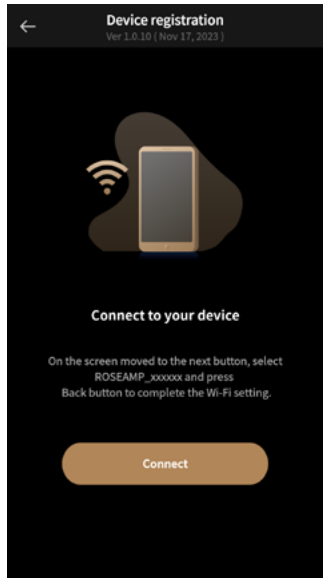
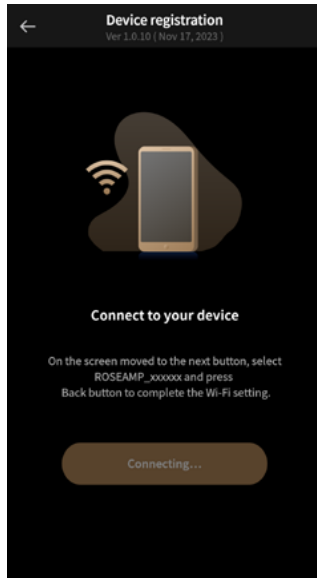
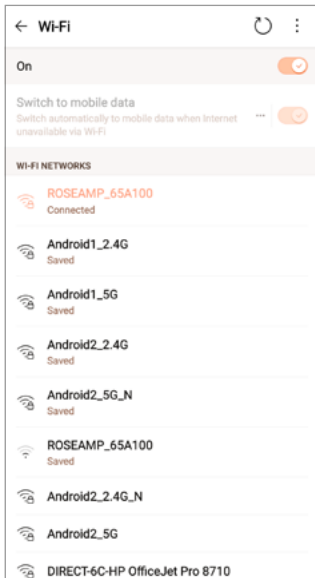

4-3-3. Amplifier Network Connection Screen

The following screen displays the connection status between the amplifier and the network. You can connect to Wi-Fi for use here.

※ The amplifier does not support dual band Wi-Fi and only supports 2.4GHz networks. Therefore, the amplifier will not connect to 5GHz networks.

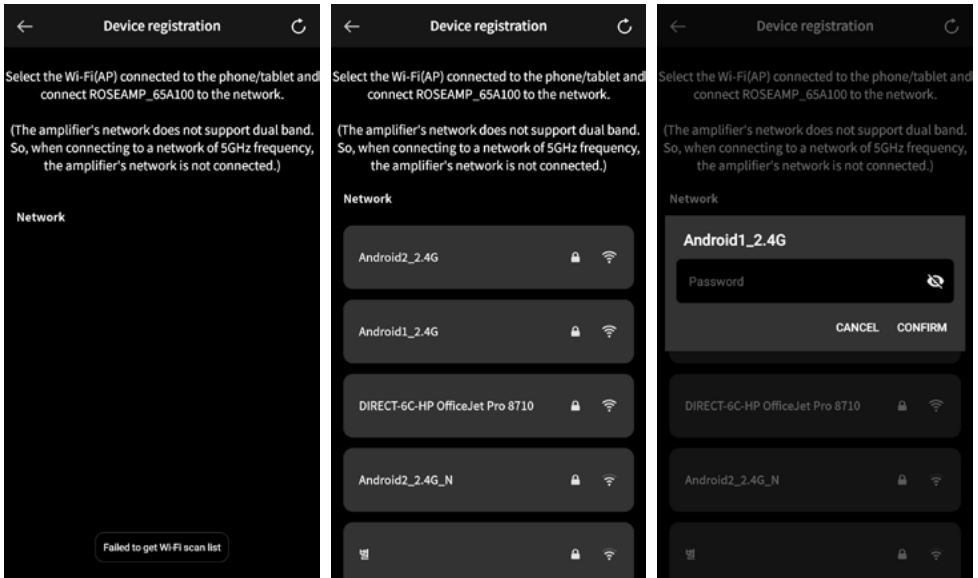

4-3-4. Amplifier Network Confirmation Screen

This screen is for checking the network connection status of the amplifier.

- Check the Wi-Fi credentials of the amplifier.
- Check the Wi-Fi connection of the amplifier.
- Check the network status of the amplifier.

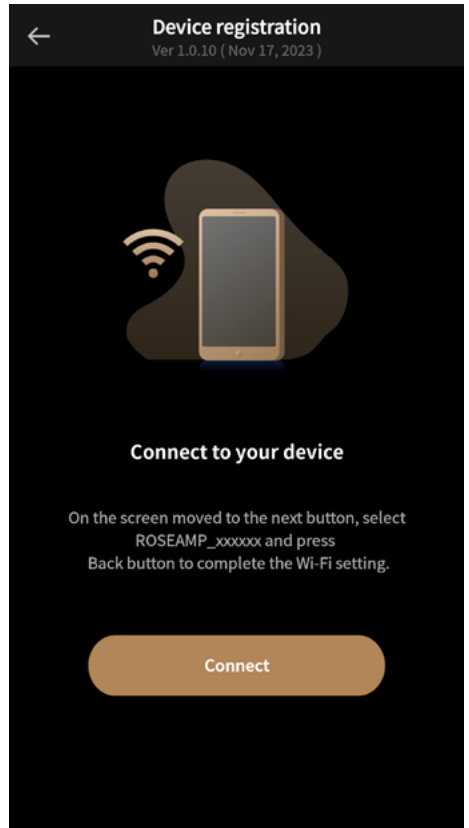
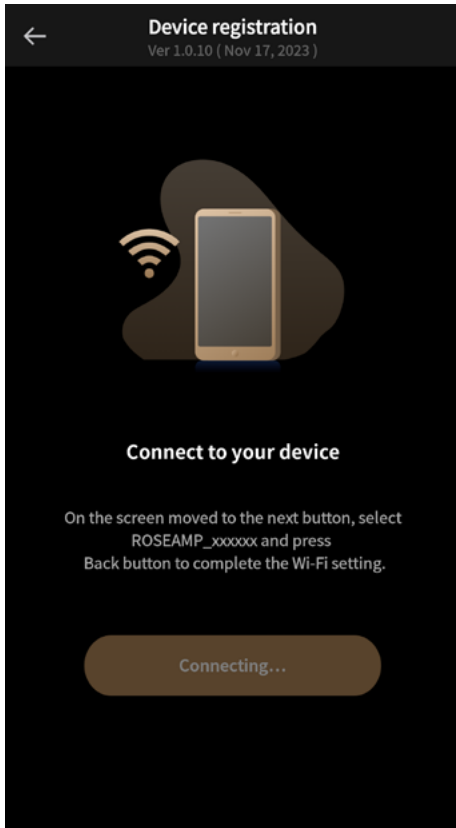

4-4. Amplifier Search Screen

Once you complete the device registration settings, move to the amplifier search screen on the first screen and search for the ROSE amplifier connected to the network that is connected to the device.

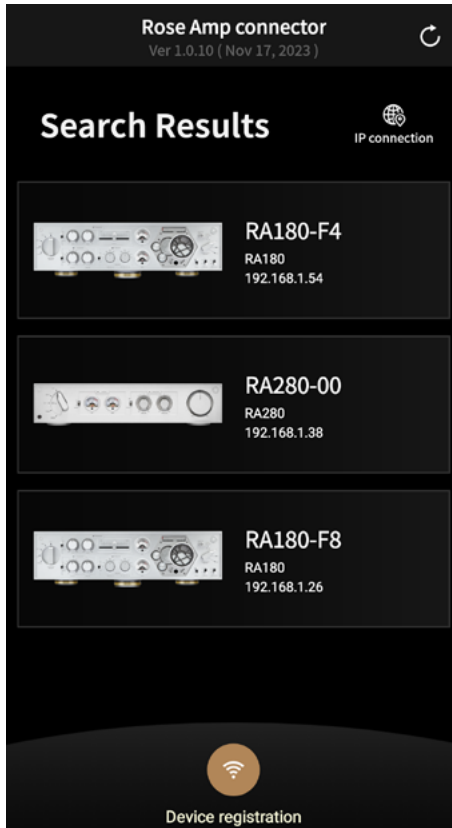

4-5. Amplifier Control Screen

When you select the RA280 amplifier from the search result list, a control screen will appear.

- **Search(Q)** : Takes you to the screen to search for amplifiers connected to the network that is connected to the device.
- **Search(C)** : Retrieves the information of the connected amplifier(s).
- **Power(P)** : Turns the amplifier power on/off. The picture on the left shows the amplifier power on, and the picture on the right shows the amplifier power off. When the amplifier is turned off, the current volume and amplifier status information are not displayed.
- **Settings(G)** : Shows the detailed settings of the amplifier (See additional description in section 4-6-1).
- **Notice(N)** : The volume of RA280 is displayed in dB units. When you press the button, the following message is displayed 'Due to the nature of the analog volume (potentiometer) controller, there may be an error in the displayed dB value.'
- **Volume** : You can view the volume value of the amplifier and adjust the volume of the amplifier using the +/- buttons (The volume cannot be adjusted using the status bar).
- **Mute(M)** : Mutes or unmutes the amplifier volume.
- **Current status information** : From the top, shows the amplifier's source information (input selector) and tone control bypass and dimmer status information.

- Power On -

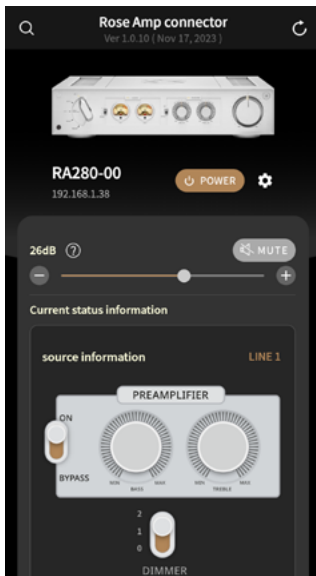

- Power Off -

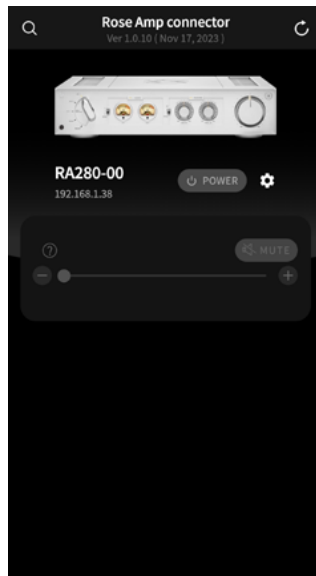

- Notice -

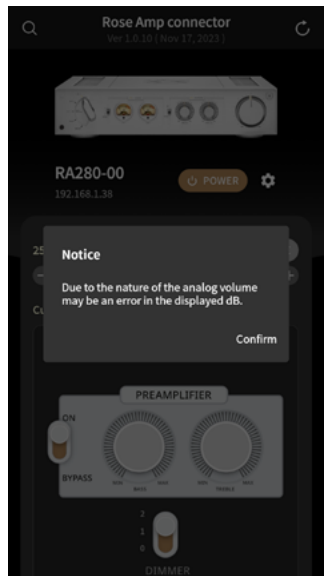

4-6. Amplifier Status Information Check

4-6-1. Amplifier Detailed Settings Screen

You can view the detailed settings of the amplifier.

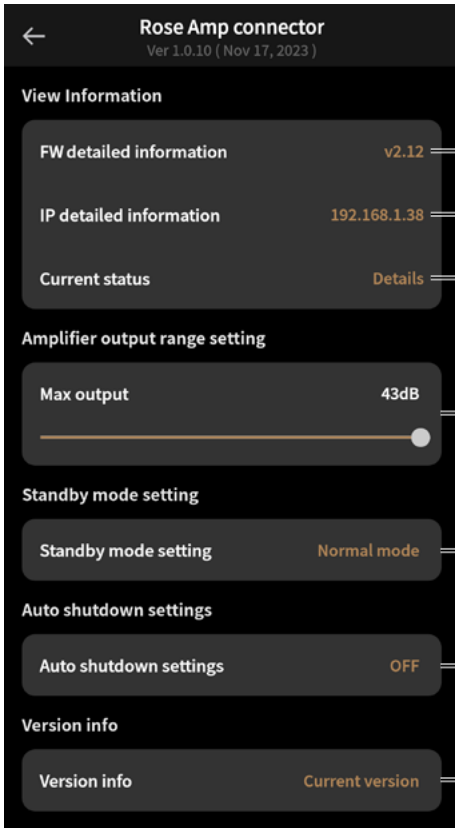

FW details : Shows the current amplifier’s firmware version (See additional description in section 4-6-2)

IP details : Shows the IP address of the current amplifier (See additional description in section 4-6-3)

Current status : Shows the status of the current amplifier’s auxiliary functions. (See additional description in section 4-6-4)

Max. output : Allows you to set the maximum output dB value of the current amplifier.

Standby mode settings : Shows and allows you to set the current standby mode (See additional description in section 4-6-5).

Automatic shutdown setting : Allows you can set the time for the amplifier to automatically shut down due to no input signal (See additional description in section 4-6-6)

Version information : Shows the version information of the current amplifier, and the Update button is activated when an update is available. Select the activated Update button to proceed with the update.

4-6-2. FW Detailed Information Screen

You can view the firmware (FW) details of the amplifier.



4-6-3. Detailed IP Information

You can view detailed information of the network to which the amplifier is connected.

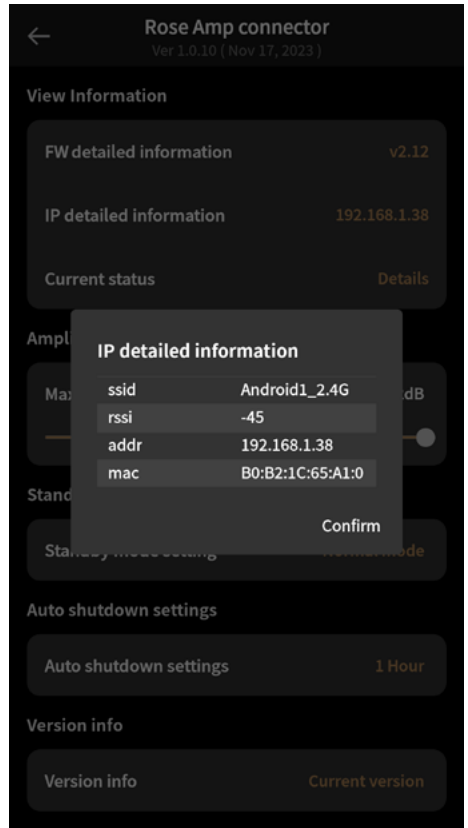

4-6-4. Current Status

You can see the status of the current amplifier's auxiliary functions. From the top, it shows information about the amplifier's tone control bypass and dimmer status.



4-6-5. Standby Mode Settings

- **Low power** : Deactivates the Wi-Fi function when the amplifier is powered off. After turning on the low power function, you can only turn on the power using the power switch or remote control. (You cannot turn on the power by operating the mobile app) This function is intended to minimize power consumption. When Wi-Fi is disabled and the power is turned off, power consumption is less than 0.5W.
- **General** : Activates the Wi-Fi function when the amplifier is powered off. After switching to normal mode, you can turn the power on/off using the mobile app. This function has the convenience of allowing you to freely turn the power on and off using the mobile app, but the power consumption when turning it off is approximately 1.2 W, which is slightly more than the low power standby mode.

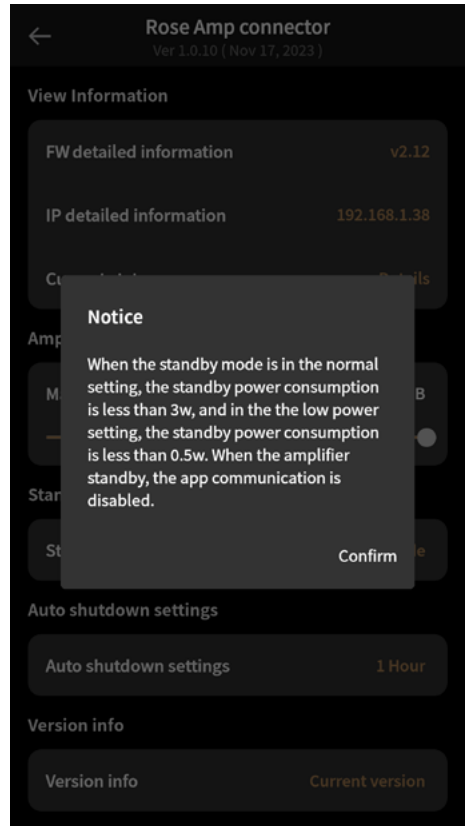
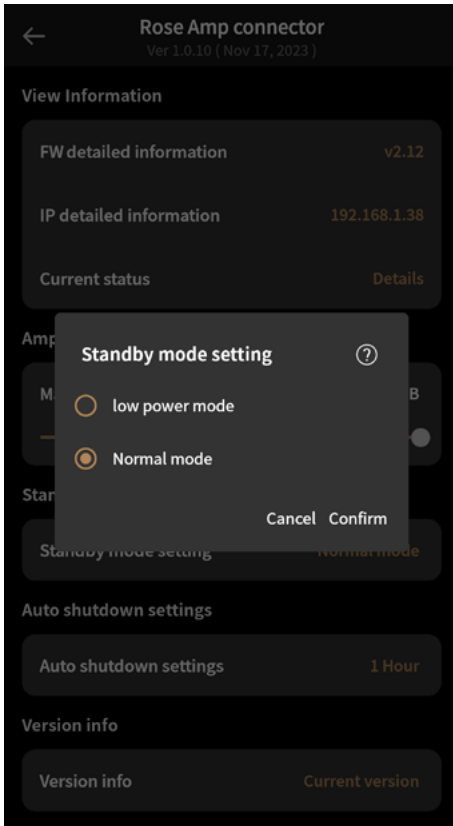

4-6-6. Automatic Shutdown Settings

You can turn the automatic shutdown function on/off or set the time.

- **OFF** : Disables the automatic shutdown function.
- **ON** : Enables the automatic shutdown function. If there is no input signal for more than the set time, the amplifier will automatically shut down.

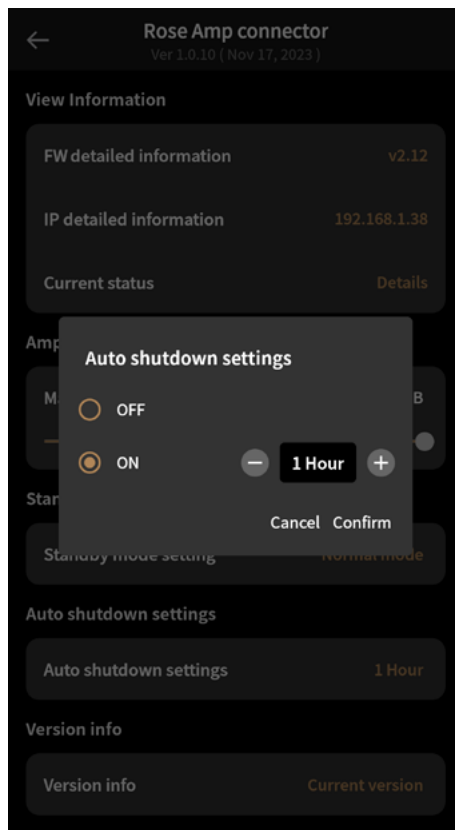

Product Specifications

※ Specifications and designs are subject to change without notice for quality improvement.

1. Specifications

Item	Condition	Specifications	Measurement Standard
Design	Size	430(W) X 355(D) X 103(H)	
	Weight	9.5kg	
	Body	Solid Aluminum, Rust-proof Steel	
Amplifier Output	4Ω	250W x 2ch (500W)	
	8Ω		
Sub Woofer Output	Mono	1Vrms (2.218 dBu)	
Input Sensitivity	Balance Input	600mV	250W x 2ch
	Unbalance Input	300mV	250W x 2ch
	Phono(MM) Input	5mV	250W x 2ch
Input Impedance	Balance Input	47kΩ	
	Unbalance Input		
	Phono(MM) Input		
Bandwidth	20Hz ~ 20kHz	+0, 0dB	250W x 2ch (8Ω Speaker Output)
	10Hz ~ 66kHz	+0, -1dB	
	10Hz ~ 85kHz	+0, -3dB	
Frequency Response	20Hz ~ 20kHz	+0, 0dB	1W x 2ch (8Ω Speaker Output)
	10Hz ~ 66kHz	+0, -1dB	
	10Hz ~ 85kHz	+0, -3dB	
THD (Total Harmonic Distortion)	Balance & Unbalance Input	0.007% (@125W)	250W x 2ch
Damping Factor	Speaker Output	>250	250W x 2ch
S/N (Signal to Noise Ratio)	Balanced / Unbalanced / Phono(MM)	109dB / 109dB / 85dB	250W x 2ch
Output Impedance	Speaker Output	30mΩ	250W x 2ch
Tone Control	Bass(100Hz) / Treble(10kHz)	±15dB	1W x 2ch (Speaker Output)
Phono(MM)	Turnover	500Hz (+13dB@100Hz)	RIAA
	Roll-off	2.1kHz (-13.7dB@10kHz)	RIAA
Power	Output Power	500W (SMPS)	Max. 600W
	Input Voltage	AC100-240V, 50/60Hz	Standby Mode Power Consumption < 0.5W
Audio In/Out on Rear	Trigger In	Voltage can be turned on 3.3V~12V	
	Trigger Out	Voltage can be turned on 12V	
Remote Control	IR Input	38kHz Infrared Ray (Within 10m of Operating Distance)	

Appendix

1. Bass Control Function of the Preamplifier

- If you turn on the tone control switch on the front side of this product and turn the BASS knob left or right, the level of the bass band (based on 100 Hz) will increase or decrease, as shown in the following figure.
- It can be adjusted from -15dB (attenuation) to +15dB (increase) in 100Hz/0dB increments.

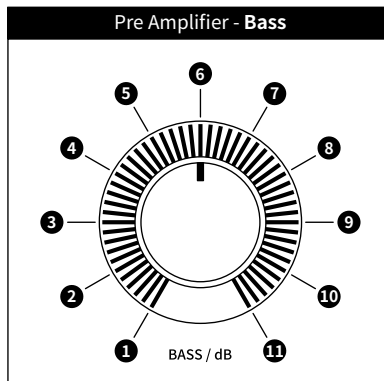
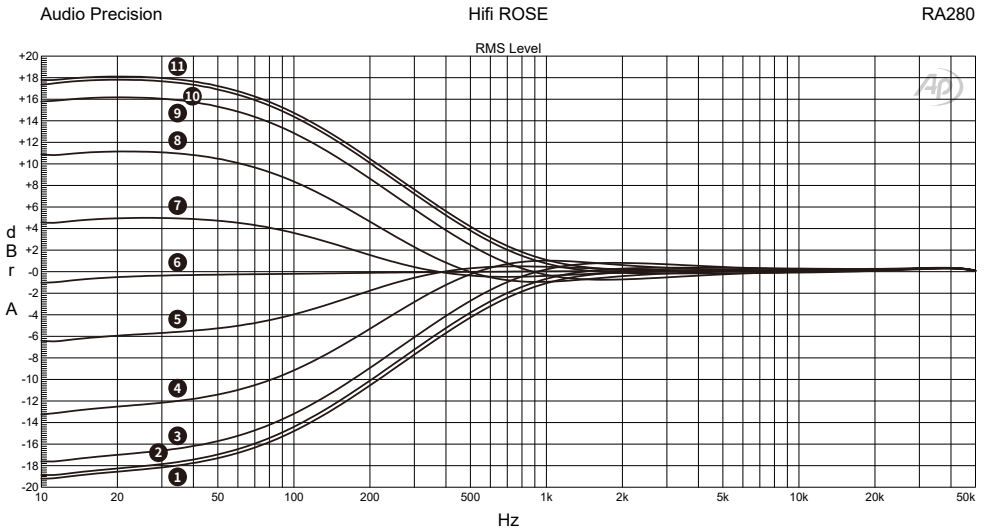

2. Treble Control Function of the Preamplifier

- If you turn on the tone control switch on the front side of this product and turn the TREBLE knob left or right, the level of the treble band (based on 10 kHz) will increase or decrease, as shown in the figure.
- It can be adjusted from -15dB (attenuation) to +15db (increase) in 10kHz/0dB increments.

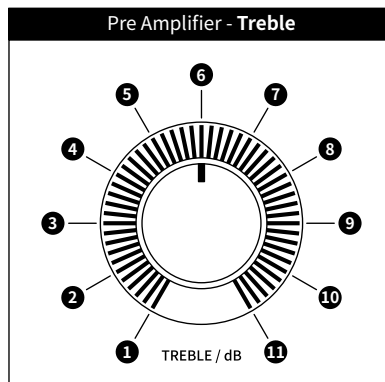
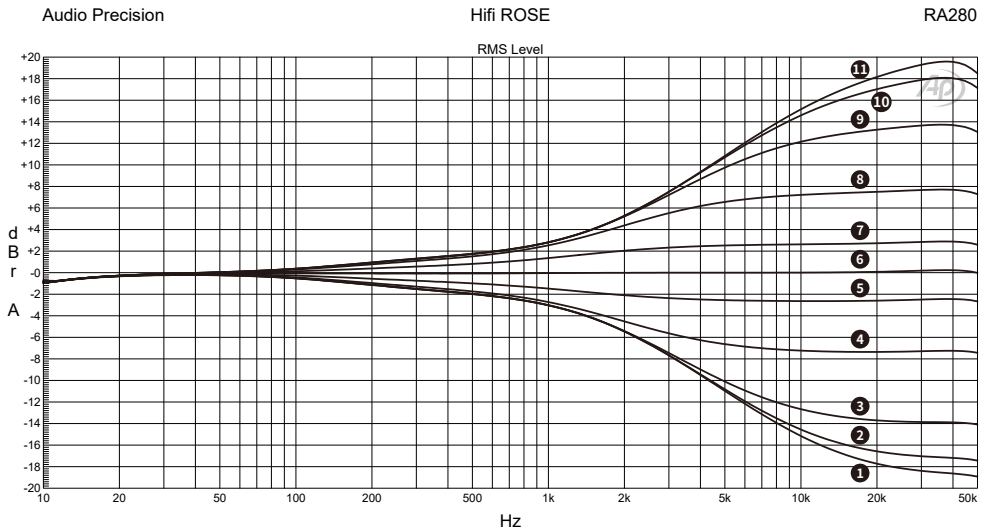

3. Phono Equalizer Curve

- The frequency characteristics of the phono amplifier of this product are as follows.

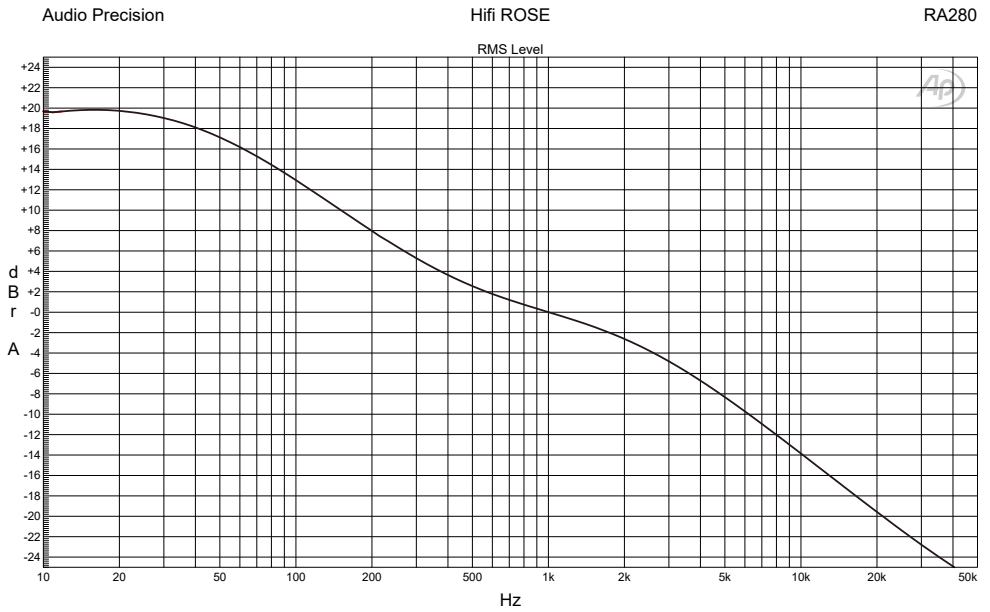



rose

Quality Guaranteed

Model Name	RA280
Purchase Date	DD / MM / 20YY
Place of Purchase	Shop Name
	Contact Address
Serial No.	
Contact Address	
Warranty Period	Until 1 year from the date of purchase

- Name of the Company that Received the Conformity Assessment: CITECH Co., Ltd.
- Manufacturer/Country of Manufacture: CI TECH Co., Ltd. / Republic of Korea
- Identification Code of the Certified Company: SYH
- Certification No.: R-R-SYH-RA280



Product Website: www.hifirose.com

- Get news about the latest events and new product information from ROSE through the newsletter.
- You can find an authorized dealer or reseller near you on the website.



Things to Check Before Contacting the Service Center

- If the switch does not work while the product is in use, it may be because it was exposed to severe static electricity. Please disconnect the power cord before starting again.
- When the product is used for a long time in a confined space that does not meet the product installation conditions (page 21), it may generate heat and become hot, affecting the life and performance of the product.
Always keep the ventilation openings on the top of the main body open so that heat dissipation inside is not disturbed.
- If the transmission is unstable or a transmission or reception failure occurs due to the nature of wireless Wi-Fi communication when using the mobile app, please move to another location and try to reconnect.
- If there is no output sound, check the input source selector of the main unit, and check that the speaker connection status, and the volume control level are not “0.”
- If the remote control does not work, the battery may be empty. Replace it with a new battery.

Repair Service Guide

• Free Repair

Limited to naturally occurring failures within one year from the date of purchase, which is the warranty period of the product.

• Paid Repair

If the warranty period has expired, or even if it is within the warranty period, in the following cases, the actual cost of repair (including part costs) will be charged.

- Failure due to consumer negligence during use
- Repairs or modifications made by persons other than company engineers
- Failure or damage caused by an abnormality in the power supply
- Failure due to a natural disaster

• Repair Service Application Guide

If a failure occurs during use, stop using it immediately and consult with the place of purchase or the customer support office of the company first.

• Information required for reporting

- Model name and serial number (manufacture date)
- Place and date of purchase
- Consumer information including contact information and address
- Symptoms of failure
- All other matters necessary for repair service

• Precautions for Product Delivery to the Service Center

Be sure to pack the product in the original box and inner protective material to prevent damage when delivering the product by courier. Please note that we are not responsible for damage to the product during transportation of the product in other packaging.