

Sonus faber

ARTISAN OF SOUND

OMNIA

WIRELESS SPEAKER

QUICK START GUIDE

1 CONTENUTO DELL'IMBALLO

1.1

Registra Omnia su sonusfaber.com e ottieni 1 anno di garanzia aggiuntivo!

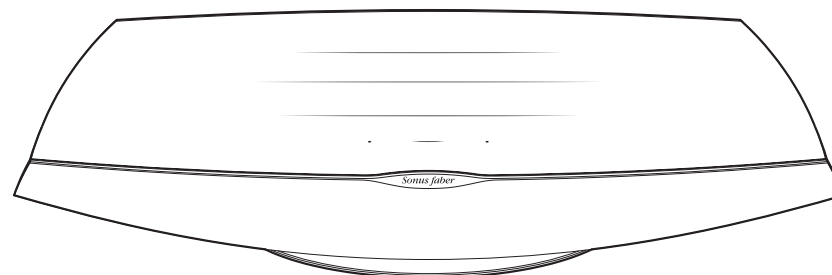

Speaker

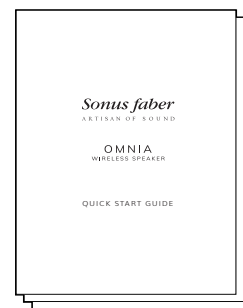

Documentazione



Telecomando



Custodia protettiva



Cavi di alimentazione

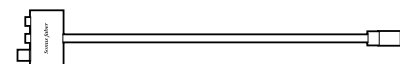

Adattatore Ingresso Phono/Linea

2 COMANDI

2.1 Speaker

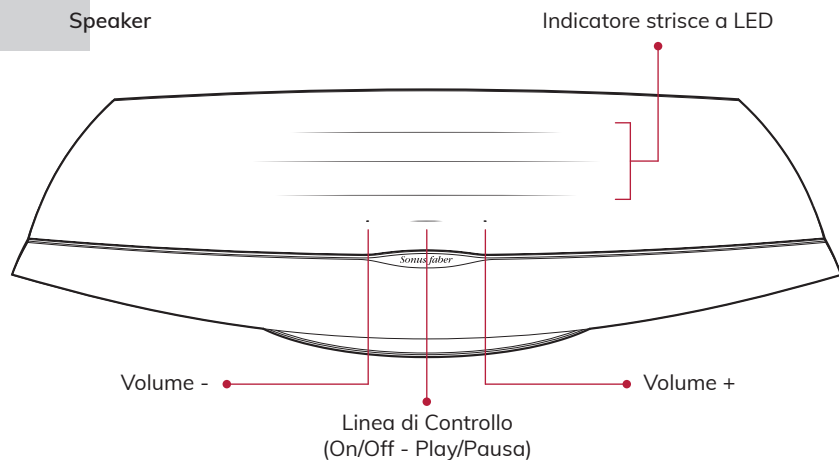

2.2 Telecomando

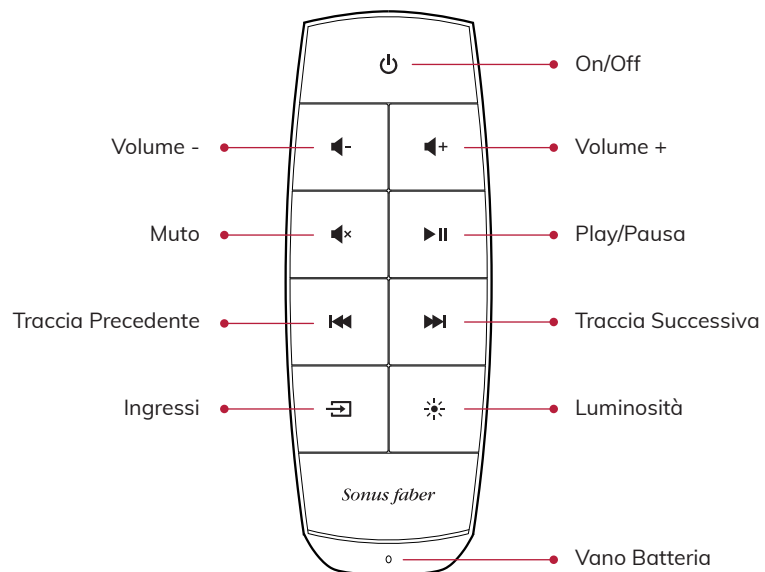

3 INPUTS

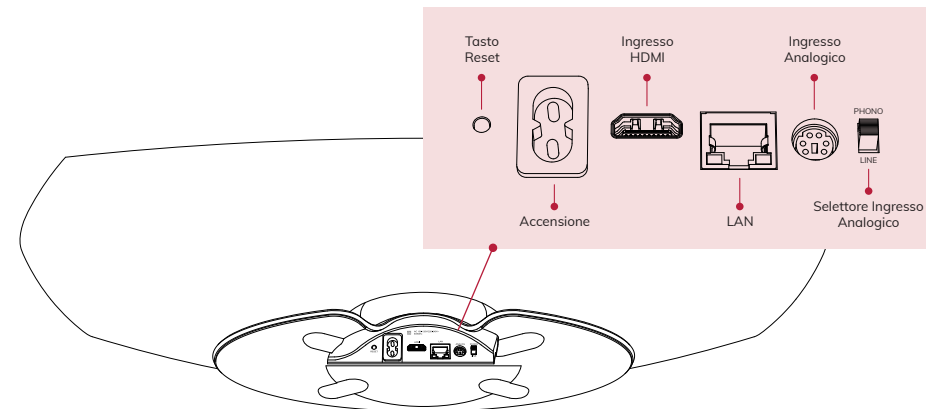

4 INIZIA

4.1

Posiziona Omnia dove intendi utilizzarla e collega il cavo di alimentazione.

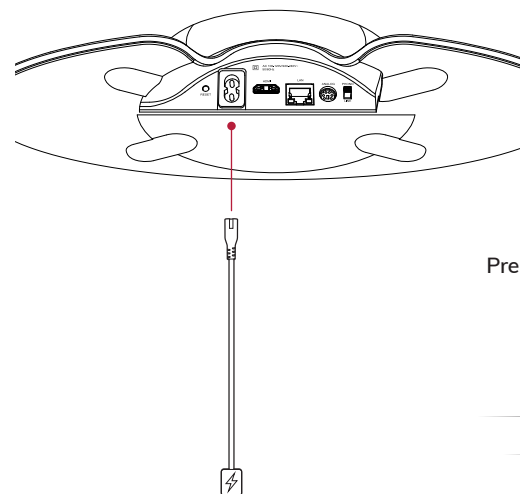

4.2

Premi la Linea di Controllo (On/Off).

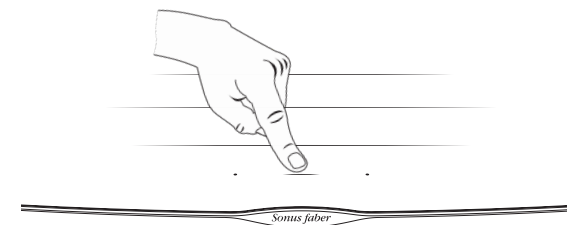

5 CONFIGURAZIONE

Quando la Linea di Controllo (Play/Pausa) lampeggia di bianco, lo speaker è pronto per la configurazione.

5.1

Dispositivi iOS

- Usando le Impostazioni Wi-Fi:**
- Vai su Impostazioni e poi su Wi-Fi
 - Seleziona Omnia-xxxxxx su Configura nuovo altoparlante AirPlay
 - Scegli la rete Wi-Fi cui connettersi
 - Clicca su Next e poi su Fatto

Usando l'App Casa:

- Installa/Aggiorna l'App Casa
- Apri l'App Casa
- Clicca su Aggiungi un accessorio
- Segui la procedura per impostare il Wi-Fi

5.2

Dispositivi Android™

- Installa/Aggiorna l'App Google Home
- Apri l'App Google Home
- Clicca su Altoparlante
- Segui la procedura per impostare il Wi-Fi

Nota Bene: Omnia e il tuo dispositivo devono essere connessi alla stessa rete Wi-Fi.

Omnia supporta entrambe le bande Wi-Fi 2.4 Ghz e 5.2Ghz.

5.3

Bluetooth

- Premi il pulsante Ingressi sul telecomando fino a che il LED della Linea di Controllo lampeggerà di blu
- Seleziona Omnia-xxxxxx dall'elenco dei dispositivi bluetooth
- Quando il LED blu della Linea di Controllo è fisso, Omnia è pronta per suonare la tua musica

5.4

Ethernet

- Collega il router ad Omnia con il cavo Ethernet

6 ASCOLTA LA TUA MUSICA

Premi il pulsante Ingressi sul telecomando per modificare la sorgente di ingresso.

La Linea di Controllo cambierà colore come feedback. Consulta il manuale online per ulteriori dettagli. L'ingresso selezionato è indicato dal colore del LED della Linea di Controllo.

- Bluetooth (blu)
- HDMI (arancione) **IMPORTANTE:** assicurati che l'uscita del TV sia impostato su PCM
- Phono (rosa) **IMPORTANTE:** assicurati che la testina sia una moving magnet (MM) con uscita di segnale compresa tra 2.4mV e 5.0mV
- App per lo streaming (bianco):
 - AirPlay (bianco)*
 - Chromecast built-in (giallo)*
 - Spotify (verde)*
 - Roon (viola)*
 - Tidal (azzurro/turchese)*

* Una volta collegata l'App di streaming dall'utente, il relativo colore Apparirà sulla Linea di Controllo di Omnia.

1 PACKAGING CONTENTS

1.1

Register Omnia on sonusfaber.com and get an additional 1 year's warranty cover!

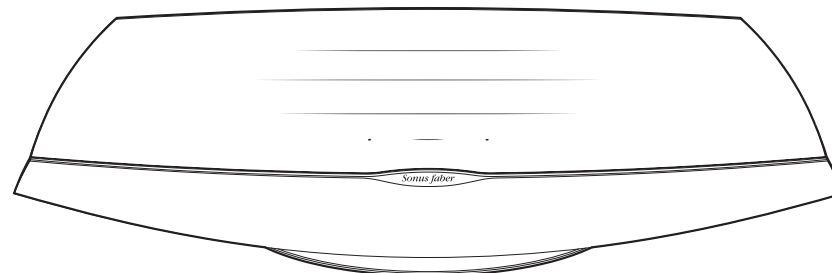

Speaker

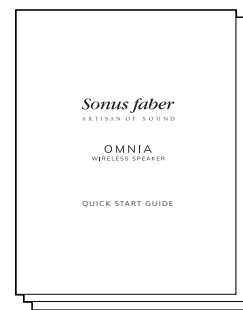

Literature

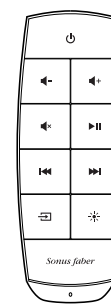

Remote control



Protective cover



Power cables

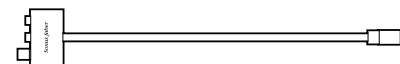

Phono/Line In adapter

2 CONTROLS

2.1 Speaker

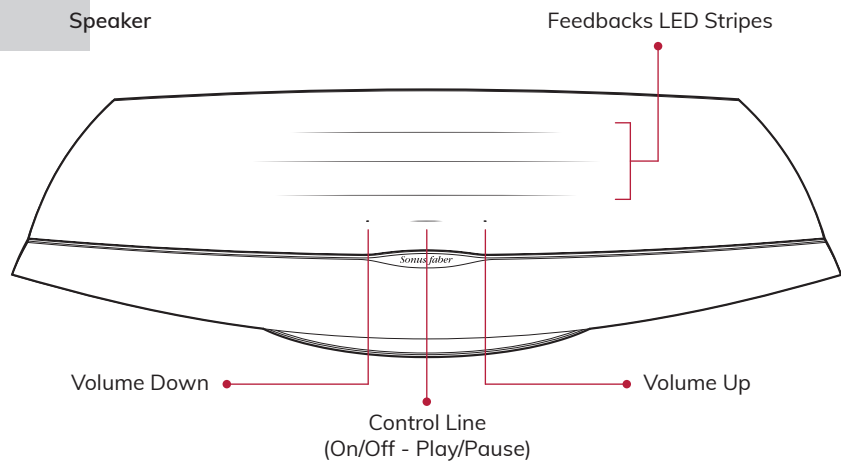

2.2 Remote Control

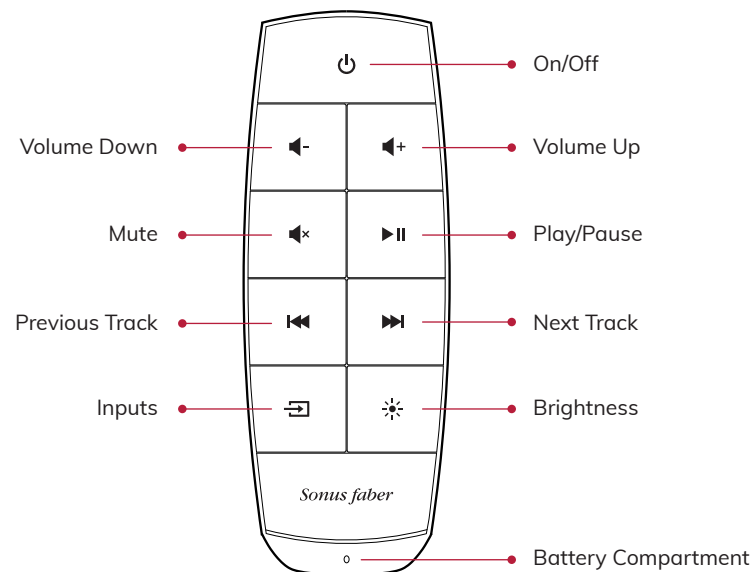

3 INPUTS

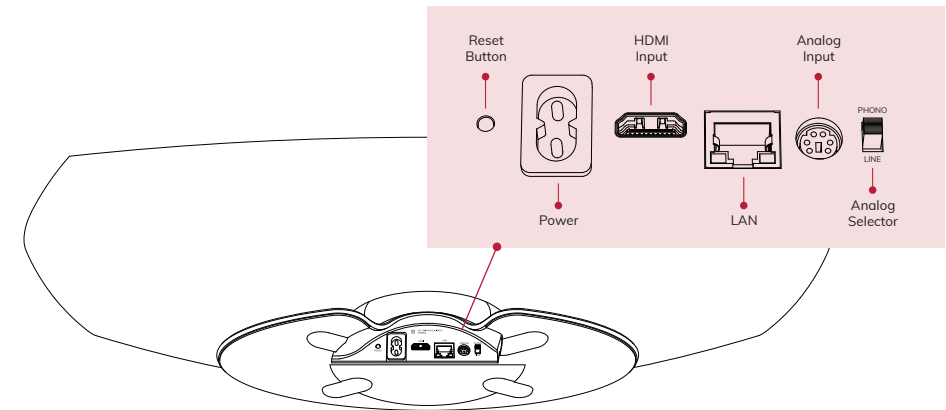

4 START

4.1

Place the Omnia where you intend to use it and connect Power Cable.

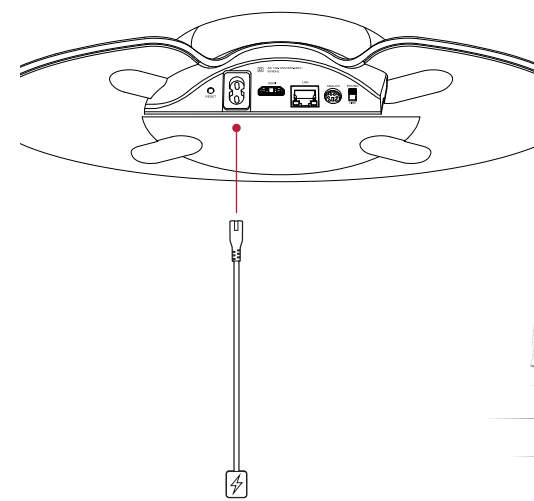

4.2

Press the Control Line (On/Off).

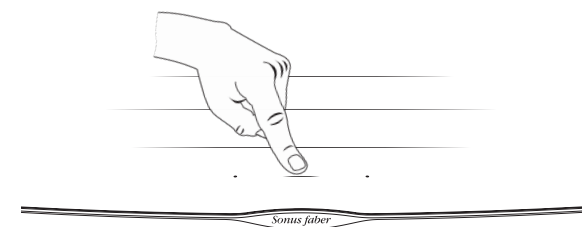

5 SET UP

When the Control Line (Play/Pause) is white blinking, the speaker is ready to configure.

5.1

iOS devices

Using Wi-Fi Settings:

- Open Settings then Wi-Fi settings
- Touch Omnia-xxxxxx under Set up new AirPlay speaker
- Choose the desired Wi-Fi network to connect with
- Touch Next and then Done

Using HOME App:

- Install/Update Home App
- Open Home App
- Press Add Accessory
- Follow the wizard to set Wi-Fi

5.2

Android™ devices

- Install/Update Google Home App
- Open Google Home App
- Press speaker
- Follow the wizard to set Wi-Fi

Please Note: Omnia and your device must be connected to the same Wi-Fi network. Omnia supports both 2.4Ghz and 5.2Ghz Wi-Fi Bands.

5.3

Bluetooth

- Press the Inputs button on the remote control until the Control Line LED flashes with a blue light
- Select Omnia-xxxxxx from the list of bluetooth devices
- When the blue LED of the Control Line has a fixed light, Omnia is ready to play your music

5.4

Ethernet

- Connect your router to Omnia via Ethernet cable

6 PLAY MUSIC

Press inputs button on remote to change input. The Control Line will change colour as feedback. See the online Owner's Manual for further details. The selected input is indicated by the LED colour of the Control Line.

- Bluetooth (blue)
- HDMI ARC (orange) IMPORTANT: ensure the TV output is set to PCM
- Phono (pink) IMPORTANT: Ensure the phono cartridge is a magnet moving (MM) with 2.4mV to 5.0mV output
- Streaming Apps (white):
 - AirPlay (white)*
 - Chromecast built-in (yellow)*
 - Spotify (green)*
 - Roon (purple)*
 - Tidal (light blue/turquoise)*

* Once the user connects the streaming App, the relative colour will Appear on the Omnia Control Line.

1 CONTENU DE L'EMBALLAGE

1.1

Enregistrez Omnia sur sonusfaber.com et obtenez 1 an de garantie supplémentaire!

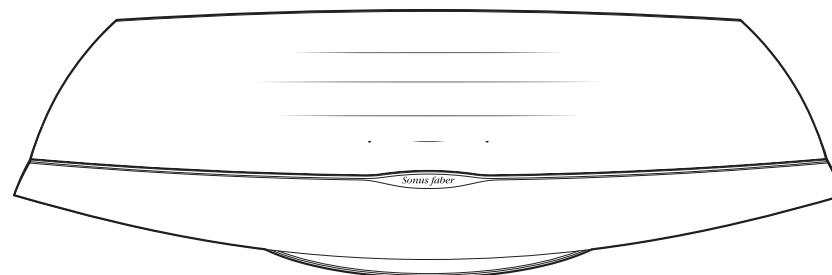

L'enceinte

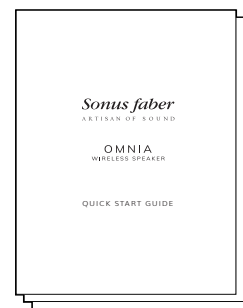

Documentation

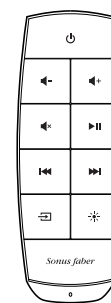

Télécommande



Couverture de protection



Câbles d'alimentation

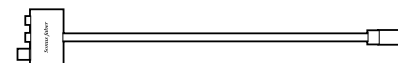

Adaptateur d'entrée Phono/Ligne

2 COMMANDES

2.1

L'enceinte

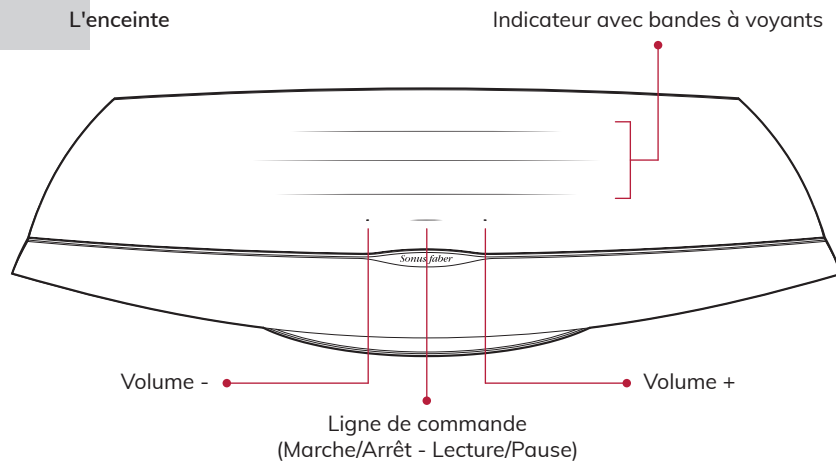

2.2

Télécommande

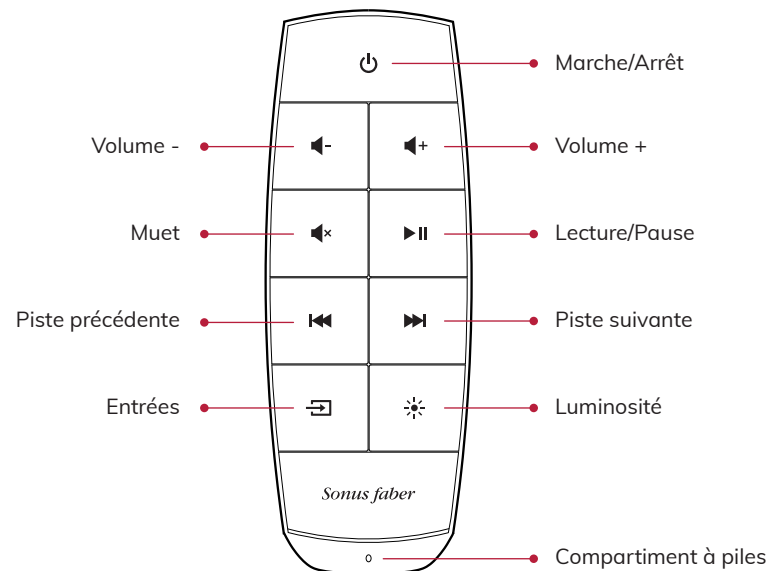

3 ENTRÉES

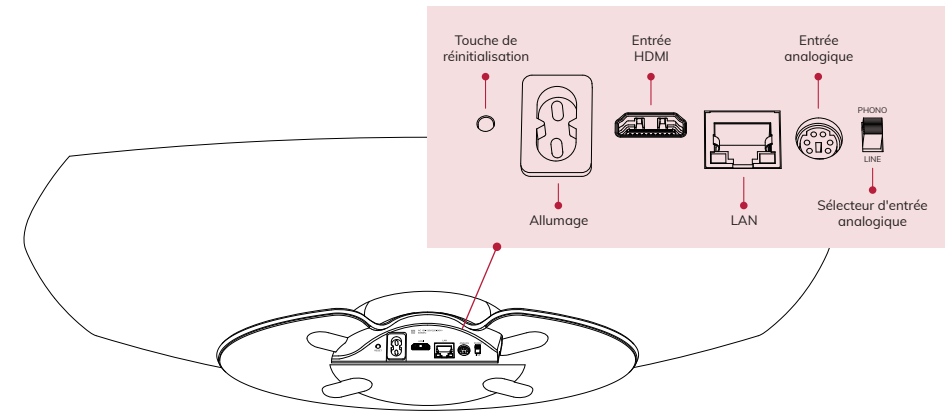

4 POUR COMMENCER

4.1

Placez Omnia là où vous souhaitez l'utiliser et branchez le cordon d'alimentation.

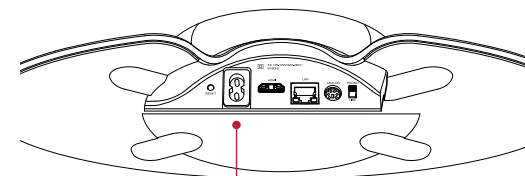

4.2

Appuyez sur la ligne de commande (Marche/Arrêt).

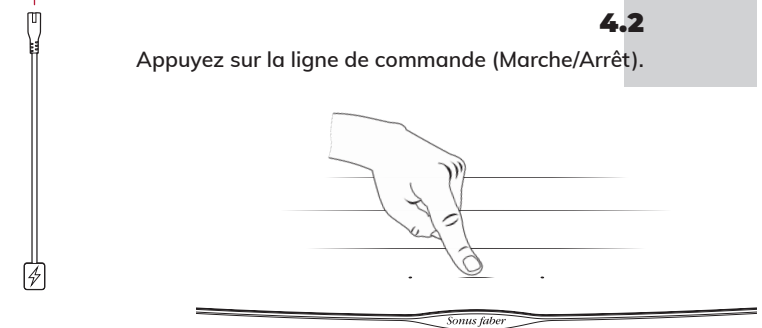

5 CONFIGURATION

Lorsque la ligne de commande (Lecture/Pause) clignote en blanc, l'enceinte est prête à être configurée.

5.1

Appareils iOS

- | | |
|---|--|
| <ul style="list-style-type: none"> • Accéder à Paramètres puis Wi-Fi • Sélectionner Omnia-xxxxxx dans Configurer un nouveau haut-parleur AirPlay • Choisir le réseau Wi-Fi auquel se connecter • Cliquer sur Suivant puis sur Terminé | <p>Avec utilisation des paramètres Wi-Fi:</p> <p>Avec utilisation de l'application Maison:</p> <ul style="list-style-type: none"> • Installer/mettre à jour l'Application Maison • Ouvrir l'Application Maison • Cliquer sur Ajouter un accessoire • Suivre la procédure indiquée pour configurer le Wi-Fi |
|---|--|

5.2

Appareils Android™

- Installer/mettre à jour l'Application Google Home
- Ouvrir l'Application Google Home
- Cliquer sur l'enceinte
- Suivre la procédure indiquée pour configurer le Wi-Fi

NB: Omnia et votre Appareil doivent être connectés au même réseau Wi-Fi.

Omnia prend en charge les bandes Wi-Fi 2,4 Ghz et 5,2 Ghz.

5.3

Bluetooth

- Appuyez sur le bouton Entrées de la télécommande jusqu'à ce que le voyant de la Ligne de commande clignote en bleu
- Sélectionnez Omnia-xxxxxx dans la liste des dispositifs bluetooth
- Lorsque le voyant bleu de la Ligne de commande devient fixe, Omnia peut alors être utilisée pour écouter votre musique préférée

5.4

Ethernet

- Connecter le routeur à Omnia en utilisant le câble Ethernet

6 ÉCOUTEZ VOTRE MUSIQUE PRÉFÉRÉE

Appuyez sur le bouton Entrées de la télécommande pour changer la source d'entrée.

La ligne de commande changera de couleur afin d'indiquer que la commande a été reçue.

Consultez le manuel en ligne pour plus de détails. L'entrée sélectionnée est indiquée par la couleur du voyant de la ligne de commande.

- Bluetooth (bleu)
- HDMI (orange) IMPORTANT : s'assurer que la sortie TV soit configurée sur PCM.
- Phono (rose) IMPORTANT : s'assurer que la cartouche soit un aimant mobile (MM) avec signal de sortie compris entre 2,4 mV et 5,0 mV
- Application pour le streaming (blanc):
 - AirPlay (blanc)*
 - Chromecast intégré (jaune)*
 - Spotify (vert)*
 - Roon (violet)*
 - Tidal (bleu clair/turquoise)*

* Une fois l'Application de streaming connectée par l'utilisateur, la couleur relative Apparaîtra sur la ligne de commande d'Omnia.

1 VERPACKUNGSINHALT

1.1

Registrieren Sie Omnia auf sonusfaber.com und erhalten Sie zusätzlich 1 Jahr Garantie!

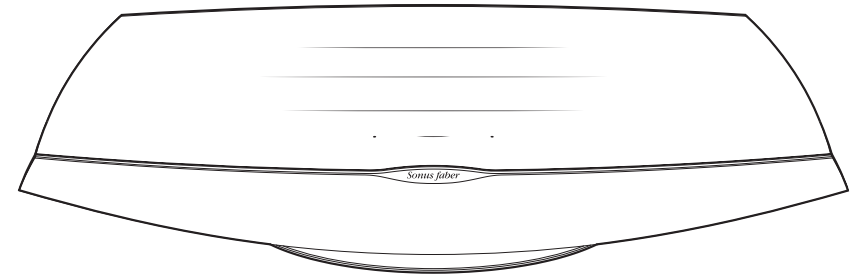

Lautsprecher

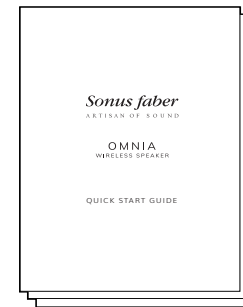

Dokumentation

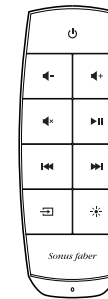

Fernbedienung



Schutzhülle

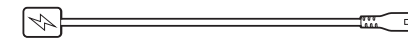

Netzkabel

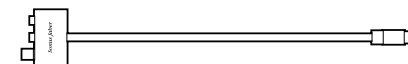

Phono/Line-In-Adapter

2 BEDIENELEMENTE

2.1

Lautsprecher

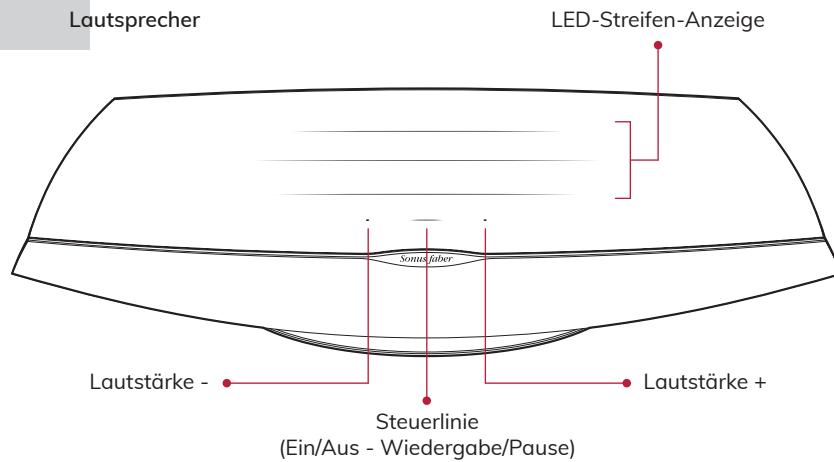

2.2

Fernbedienung

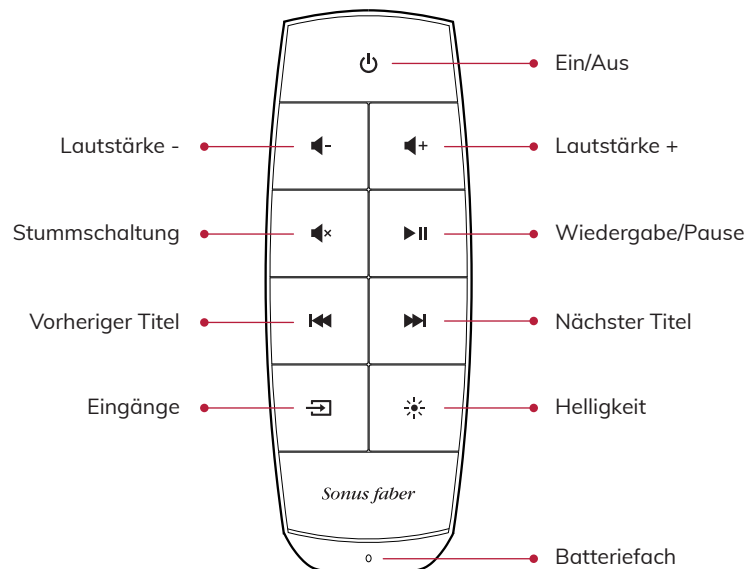

3 EINGÄNGE

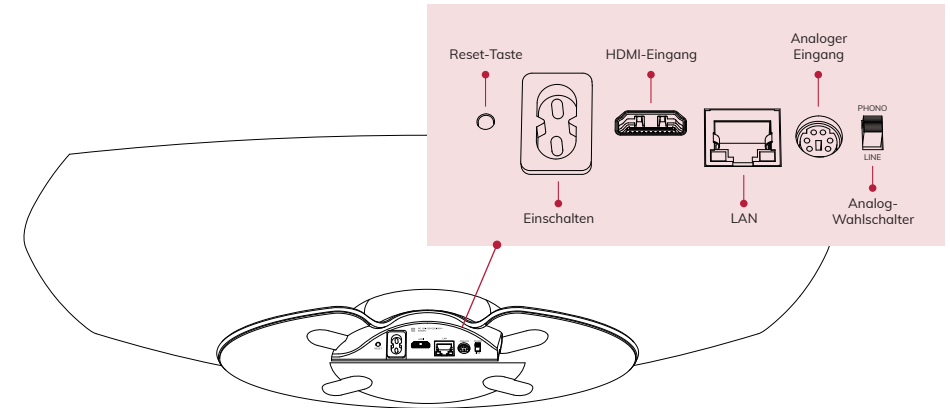

4 START

4.1

Stellen Sie den Omnia an dem Ort auf, an dem Sie ihn verwenden möchten, und schließen Sie das Netzkabel an.

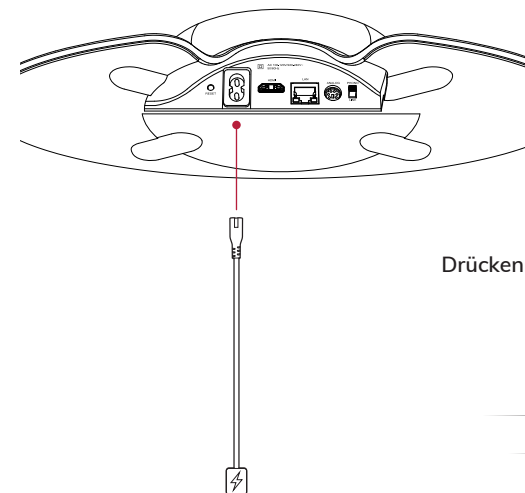

4.2

Drücken Sie auf die Steuerlinie (Ein/Aus).

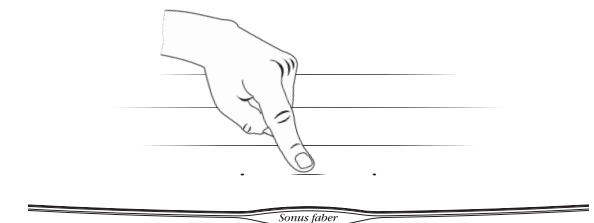

5 KONFIGURATION

Wenn die Steuerlinie (Play/Pause) weiß blinkt, ist der Lautsprecher bereit für die Einrichtung.

5.1

iOS-Geräte

Wi-Fi-Einstellungen verwenden:

- Gehen Sie zu Einstellungen und dann zu Wi-Fi
- Wählen Sie Omnia-xxxx unter Neuen AirPlay-Lautsprecher einrichten
- Wählen Sie das Wi-Fi-Netzwerk, mit dem Sie sich verbinden möchten
- Klicken Sie auf Weiter und dann auf Fertig

Verwenden der Home-App:

- Installieren/aktualisieren Sie die Home-App
- Öffnen Sie die Home-App
- Klicken Sie auf Zubehör hinzufügen
- Folgen Sie den Schritten zum Einrichten des Wi-Fi

5.2

Android™-Geräte

- Installieren/aktualisieren Sie die Google Home-App
- Öffnen Sie die Google Home-App
- Klicken Sie auf Lautsprecher
- Folgen Sie den Schritten zum Einrichten des Wi-Fi

Bitte beachten: Der Omnia und Ihr Gerät müssen mit demselben Wi-Fi-Netzwerk verbunden sein. Omnia unterstützt sowohl das 2,4-GHz- als auch das 5,2-GHz-Wi-Fi-Band.

5.3

Bluetooth

- Drücken Sie die Taste Inputs auf der Fernbedienung, bis die LED der Steuerlinie blau blinkt
- Wählen Sie Omnia-xxxx aus der Liste der Bluetooth-Geräte aus
- Wenn die blaue LED der Steuerlinie kontinuierlich leuchtet, ist der Omnia bereit, Ihre Musik abzuspielen

5.4

Ethernet

- Verbinden Sie den Router über das Ethernet-Kabel mit dem Omnia

6 MUSIK HÖREN

Drücken Sie die Taste Eingänge auf der Fernbedienung, um die Eingangsquelle zu ändern. Die Steuerlinie ändert ihre Farbe als Rückmeldung. Weitere Einzelheiten finden Sie im Online-Handbuch. Der gewählte Eingang wird durch die Farbe der Steuerzeilen-LED angezeigt.

- Bluetooth (blau)
- HDMI (orange) WICHTIG: Stellen Sie sicher, dass der TV-Eingang auf PCM eingestellt ist
- Phono (rosa) WICHTIG: Vergewissern Sie sich, dass es sich um einen Moving-Magnet-Tonabnehmer (MM) mit einem Ausgangssignal zwischen 2,4 mV und 5,0 mV handelt
- Streaming-Apps (weiß):
 - AirPlay (weiß)*
 - Chromecast built-in (gelb)*
 - Spotify (grün)*
 - Roon (lila)*
 - Tidal (hellblau/türkis)*

* Sobald die Streaming-App vom Benutzer verbunden wurde, wird die entsprechende Farbe auf der Omnia-Steuerzeile angezeigt.

1 CONTENIDO DEL EMBALAJE

1.1

¡Registra Omnia en sonusfaber.com y recibirás 1 año de garantía adicional!

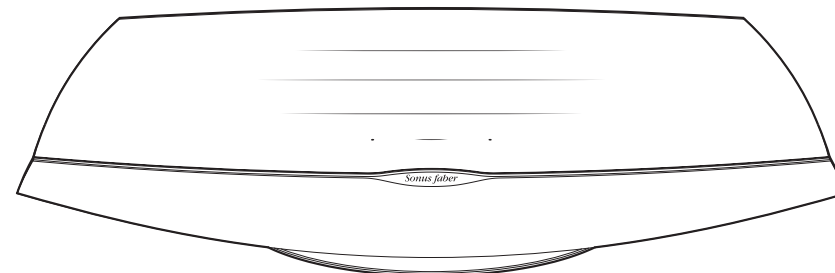

Altavoz

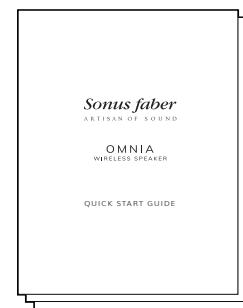

Documentos

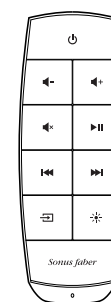

Mando a distancia



Cubierta de protección

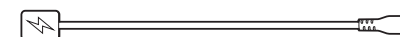

Cable de alimentación

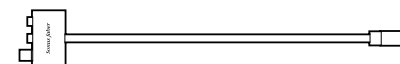

Adaptador Entrada Audio/Línea

2 MANDOS

2.1 Altavoz

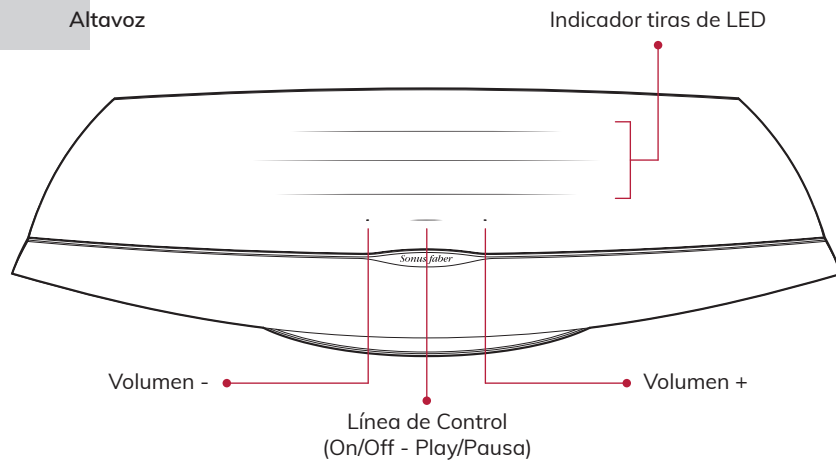

2.2 Mando a distancia

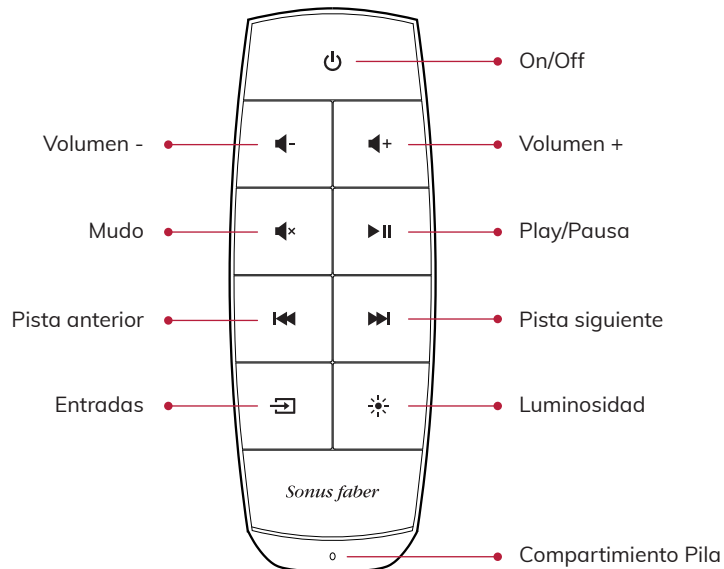

3 ENTRADAS

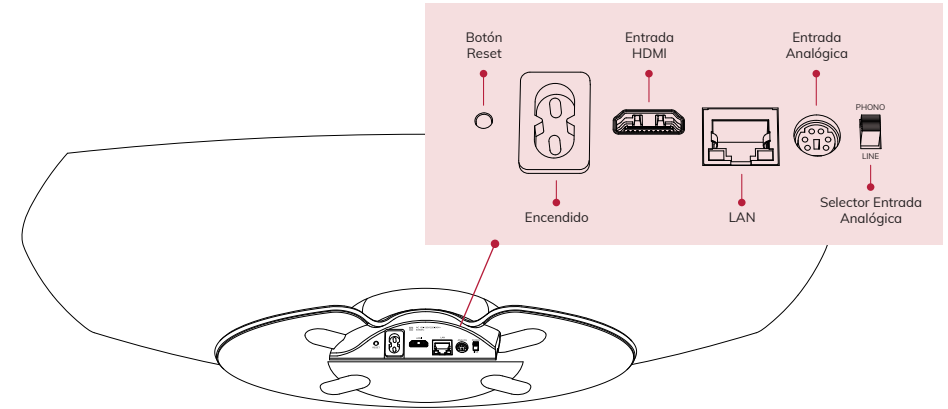

4 INICIAR

4.1

Colocar Omnia donde se desea utilizar y conectar el cable de alimentación.

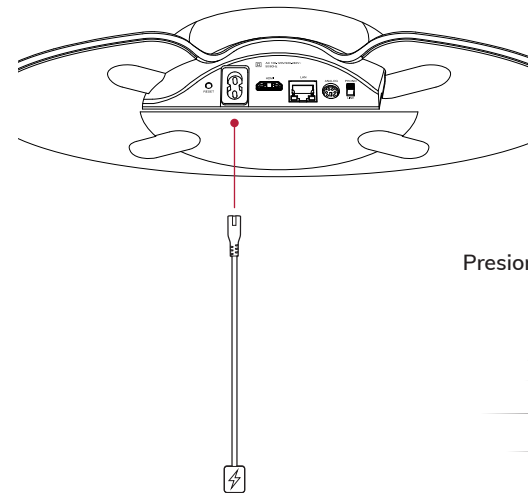

4.2

Presionar la Línea de Control (On/Off).

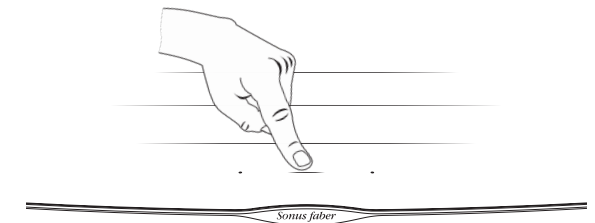

5 CONFIGURACIÓN

Cuando la Línea de Control (Play/Pausa) parpadea de color blanco, el altavoz está listo para la configuración.

5.1

Dispositivos iOS

Utilizando los Ajustes del Wi-Fi:

- Entrar en Configuración y a continuación en Ajustes del Wi-Fi
- Seleccionar Omnia-xxxxxx en Configurar nuevo altavoz AirPlay
- Seleccionar la red Wi-Fi a la que se desea conectar
- Hacer clic en Siguiente y después en Hecho

Utilizando la App Casa:

- Instala/Actualiza la App Casa
- Abre la App Casa
- Haz clic en Añadir un accesorio
- Sigue el procedimiento para configurar el Wi-Fi

5.2

Dispositivos Android™

- Instala/Actualiza la App Google Home
- Abre la App Google Home
- Haz clic en Altavoz
- Sigue el procedimiento para configurar el Wi-Fi

Nota: Omnia y tu dispositivo deben conectarse a la misma red Wi-Fi.

Omnia es compatible con las Bandas Wi-Fi de 2,4 Ghz y 5,2 Ghz.

5.3

Bluetooth

- Presionar el pulsador Entradas en el mando a distancia hasta que el LED de la Línea de Control parpadee de color azul
- Selecciona Omnia-xxxxxx de la lista de los dispositivos bluetooth
- Cuando el LED azul de la Línea de Control permanezca fijo, Omnia estará listo para tocar tu música

5.4

Ethernet

- Conecta el enrutador a Omnia con el cable Ethernet

6 ESCUCHA TU MÚSICA

Presiona el pulsador Entradas en el mando a distancia para modificar la fuente de entrada. La Línea de Control cambiará de color como respuesta. Consulta el manual online para conocer más detalles. La entrada seleccionada se indica mediante el color del LED de la Línea de Control.

- Bluetooth (azul)
- HDMI (naranja) **IMPORTANTE:** asegurarse de que la salida de la TV esté en PCM
- Audio (rosa) **IMPORTANTE:** asegurarse de que el cartucho fonográfico sea un imán móvil (MM) con salida de 2,4 mV a 5,0 mV
- App para el streaming (blanco):
 - AirPlay (blanco)*
 - Chromecast built-in (amarillo)*
 - Spotify (verde)*
 - Roon (violeta)*
 - Tidal (celeste/turquesa)*

* Una vez que se conecta la App de streaming del usuario, el respectivo color aparecerá en la Línea de Control Omnia.

1 CONTEÚDO DA EMBALAGEM

1.1

Registe Omnia em sonusfaber.com e obtenha 1 ano de garantia adicional!

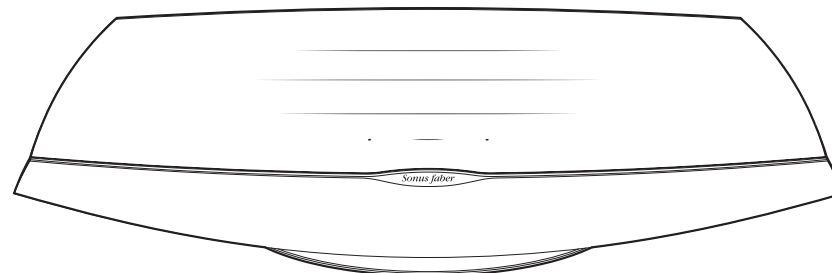

Altifalante

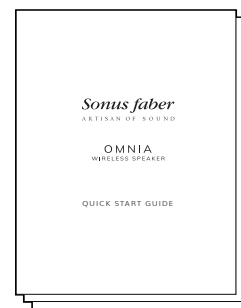

Documentação

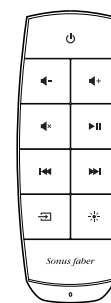

Controlo remoto



Estojo protetor

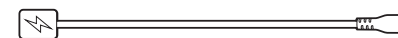

Cabos de alimentação

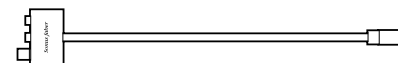

Adaptador de entrada Fone/Linha

2 COMANDOS

2.1

Altifalante

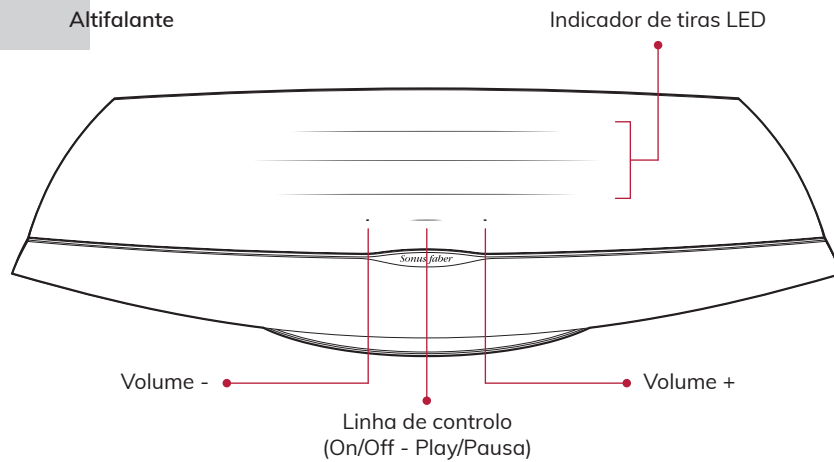

2.2

Controlo remoto

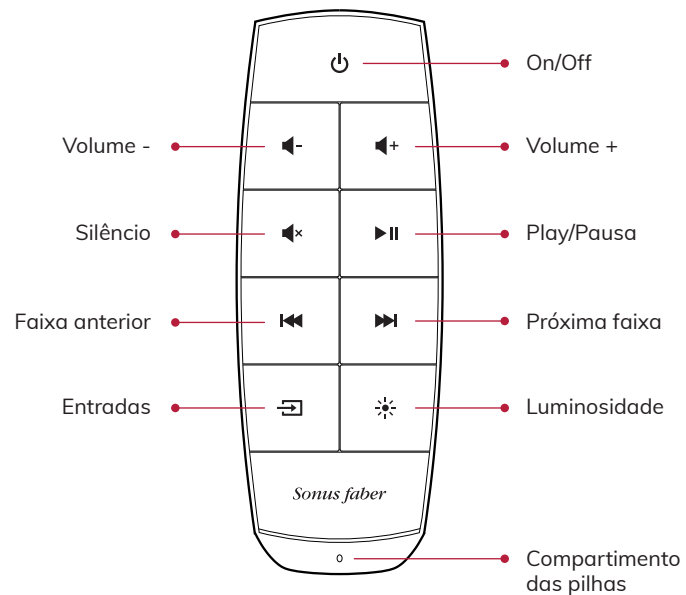

3 ENTRADAS

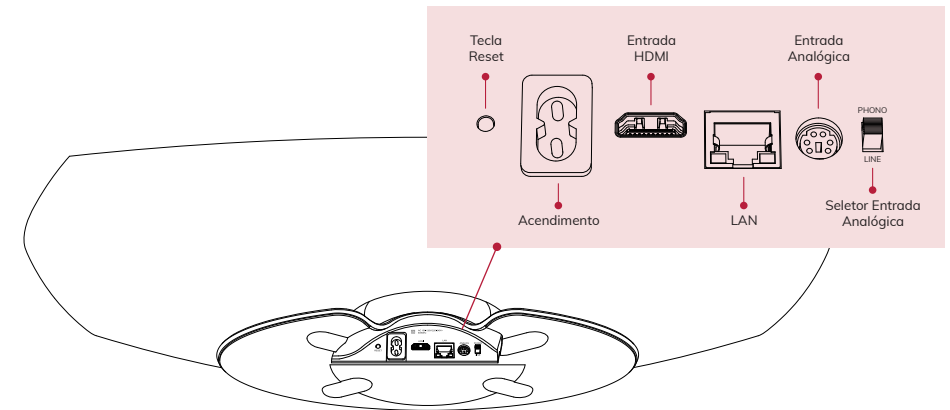

4 INICIAR

4.1

Coloque o Omnia onde pretende usá-lo e conecte o cabo de alimentação.

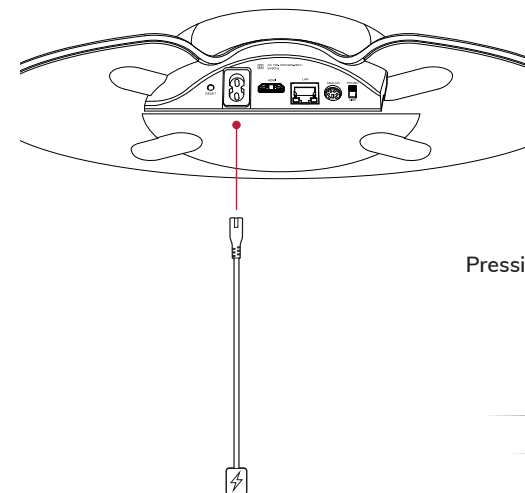

4.2

Pressione a linha de controlo (On/Off).

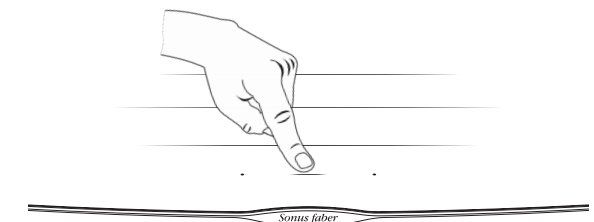

5 CONFIGURAÇÃO

Quando a linha de controlo (Play/Pausa) pisca em branco, o altifalante está pronto para a configuração.

5.1

Dispositivos iOS

Utilizar as Configurações Wi-Fi:

- Acesse a Configurações e depois a Wi-Fi
- Selecione Omnia-xxxxxx em Configurar novo altifalante AirPlay
- Escolha a rede Wi-Fi à qual pretende ligar-se
- Clique em Next e depois em Concluído

Utilizar o App Casa:

- Instalar/Atualizar o aplicativo Casa
- Abra o aplicativo Casa
- Clique em Adicionar um acessório
- Siga os passos para configurar o Wi-Fi

5.2

Dispositivos Android™

- Instalar/Atualizar o aplicativo Google Home
- Abra o aplicativo Google Home
- Clique em altifalante
- Siga os passos para configurar o Wi-Fi

Observação: Omnia e o seu dispositivo devem estar conectados à mesma rede Wi-Fi. Omnia suporta ambas as bandas Wi-Fi de 2,4 Ghz e 5,2 Ghz.

5.3

Bluetooth

- Pressione o botão Entradas no controlo remoto até que o LED da Linha de Controlo pisque em azul
- Selecione Omnia-xxxxxx na lista de dispositivos Bluetooth
- Quando o LED azul da Linha de Controlo é fixo, a Omnia está pronta para reproduzir a sua música

5.4

Ethernet

- Ligue o router ao Omnia com cabo Ethernet

6 OUÇA A SUA MÚSICA

Pressione o botão Entradas no controlo remoto para mudar de fonte de entrada. A linha de controlo mudará de cor como feedback. Consulte o manual online para obter mais detalhes. A entrada selecionada é indicada pela cor do LED da linha de controlo.

- Bluetooth (azul)
- HDMI (laranja) **IMPORTANTE:** certifique-se de que a saída da TV esteja configurada para PCM
- Fone (rosa) **IMPORTANTE:** certifique-se de que a cabeça seja um moving magnet (MM) com saída de sinal entre 2,4mV e 5,0mV
- Aplicativo para o Streaming (branco):
 - AirPlay (branco)*
 - Chromecast built-in (amarelo)*
 - Spotify (verde)*
 - Roon (roxo)*
 - Tidal (azul escuro/turquesa)*

* Assim que o aplicativo de streaming for ligado pelo utilizador, a sua cor aparecerá na linha de controlo Omnia.

1 INHOUD VAN DE VERPAKKING

1.1

Registreer Omnia op sonusfaber.com en ontvang 1 jaar extra garantie!

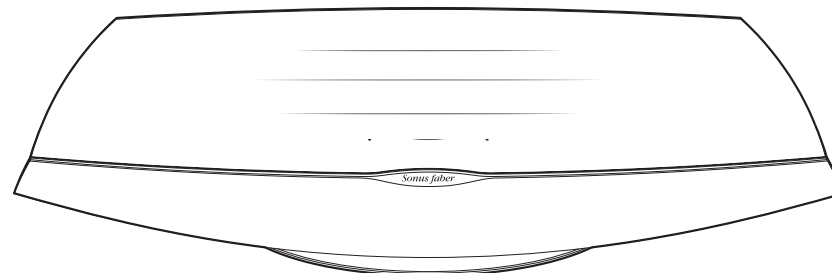

Luidspreker

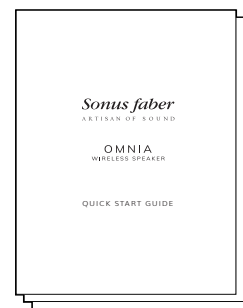

Documentatie

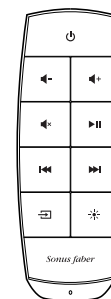

Afstandsbediening



Beschermzakje

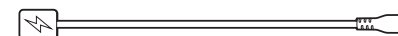

Voedingskabels

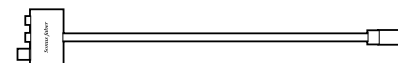

Adapter ingang Geluid/Lijn

2 BEDIENINGEN

2.1 Luidspreker

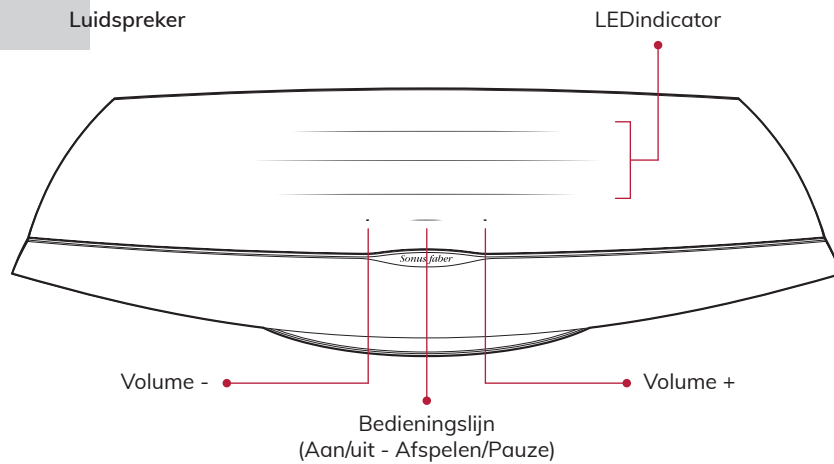

2.2 Afstandsbediening

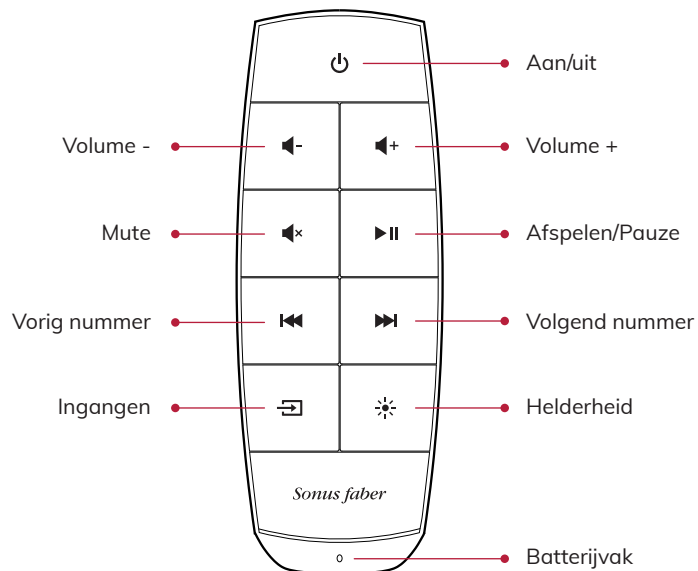

3 INGANGEN

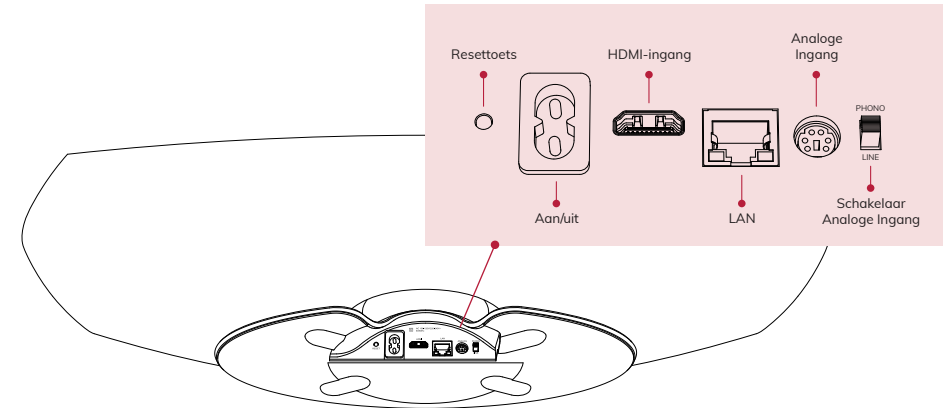

4 STARTEN

4.1 Breng Omnia aan op de gewenste plek en sluit de voedingskabel aan.

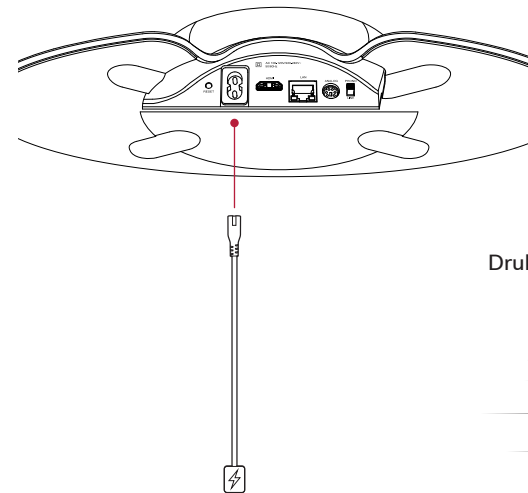

4.2

Druk op de bedieningslijn (Aan/Uit).

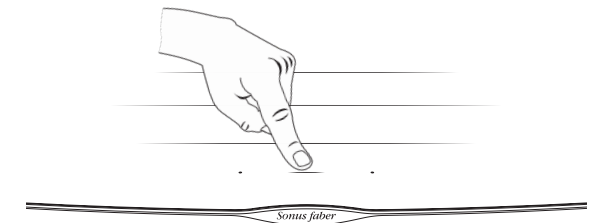

5 CONFIGURATIE

De luidspreker is gereed voor de configuratie als de bedieningslijn (Afspelen/Pauze) wit knippert.

5.1 iOS- devices

Wi-Fi-instellingen gebruiken:

- Ga naar Instellingen en daarna naar Wi-Fi
- Selecteer Omnia-xxxxxx in Nieuwe AirPlay-luidspreker configureren
- Kies het gewenste Wi-Fi-netwerk voor de verbinding
- Klik op Verder en op Gedaan

Met de App Woning:

- Installeer/update de App Woning
- Open de App Woning
- Klik op Accessoires toevoegen
- Stel de Wi-Fi in door de procedure te volgen

5.2 Android™- devices

- Installeer/update de App Google Home
- Open de App Google Home
- Klik op Luidspreker
- Stel de Wi-Fi in door de procedure te volgen

Nota Bene: Omnia en uw device moeten op hetzelfde Wi-Fi-netwerk zijn aangesloten. Omnia ondersteunt de beide Wi-Fi-banden 2.4 Ghz en 5.2Ghz.

5.3 Bluetooth

- Houd de knop Ingangen op de afstandsbediening ingedrukt tot de LED van de bedieningslijn blauw begint te knipperen
- Selecteer Omnia-xxxxxx uit de lijst van bluetooth-devices
- Omnia kan uw muziek afspelen als de blauwe LED van de bedieningslijn vast brandt

5.4 Ethernet

- Sluit Omnia met de Ethernet-kabel aan op de router

6 NAAR MUZIEK LUISTEREN

Wijzig de ingangsbron door op de knop Ingangen op de afstandsbediening te drukken. De bedieningslijn wijzigt van kleur om dit aan te geven. Raadpleeg de online handleiding voor meer informatie. De kleur van de LED van de bedieningslijn geeft de geselecteerde ingang aan.

- Bluetooth (blauw)
- HDMI (oranje) BELANGRIJK: controleer of de uitgang van de TV is ingesteld op PCM
- Geluid (roze) BELANGRIJK: controleer of de pickupnaald een magnetisch bewegende pickupnaald (MM) is met een uitgangssignaal van 2,4mV tot 5,0mV
- Streaming-App (wit):
 - AirPlay (wit)*
 - Chromecast built-in (geel)*
 - Spotify (groen)*
 - Roon (paars)*
 - Tidal (lichtblauw/turkoois)*

* Zodra de streaming-App van de gebruiker gekoppeld is, wordt de desbetreffende kleur op de bedieningslijn van Omnia weergegeven.

1 ZAWARTOŚĆ OPAKOWANIA

1.1

Zarejestruj Omnię na sonusfaber.com i otrzymaj dodatkowy rok gwarancji!

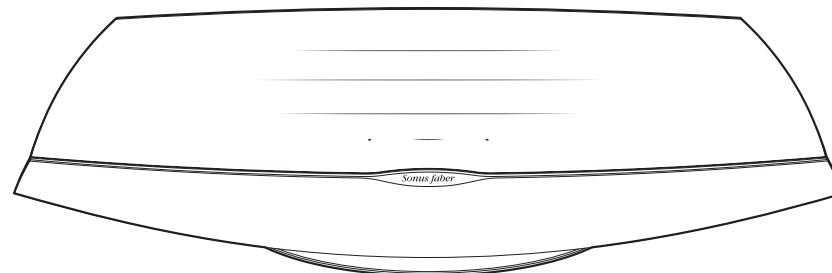

Głośnik

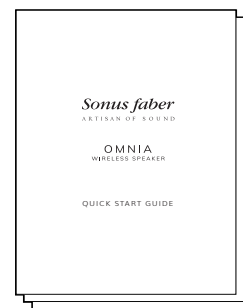

Dokumentacja

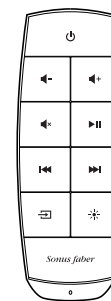

Pilot



Obudowa ochronna



Kable zasilające

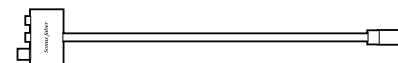

Adaptor wejścia Phono/Linea

2 POLECENIA

2.1 Głośnik

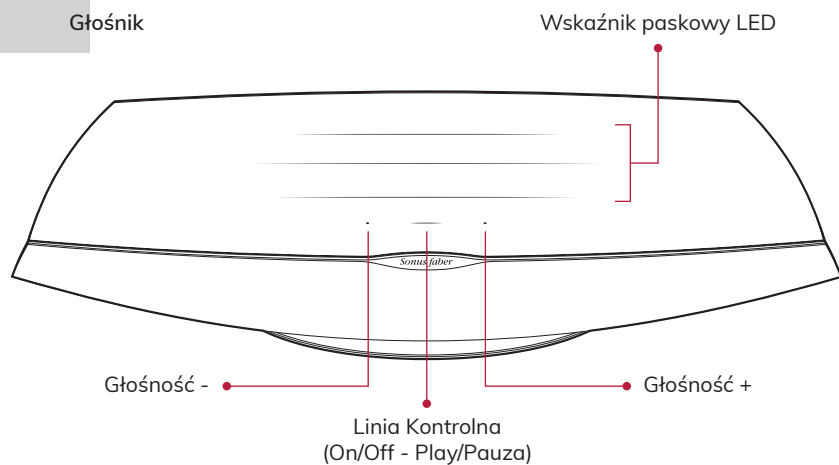

2.2 Pilot

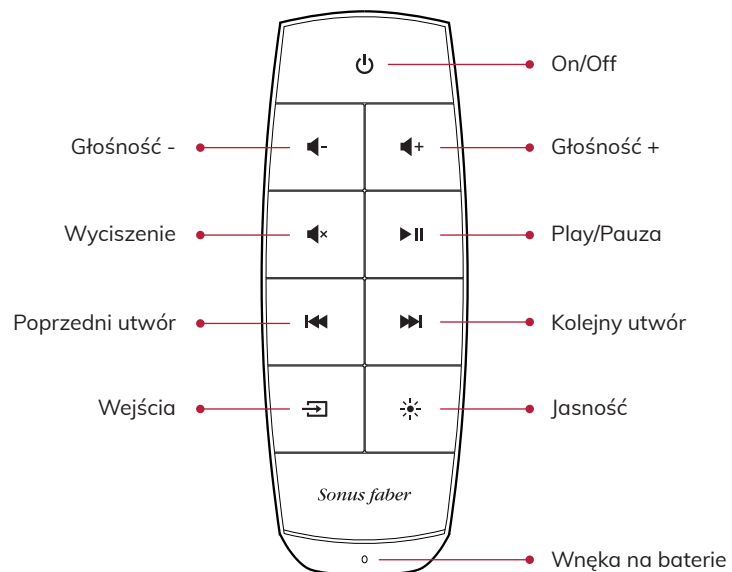

3 WEJŚCIA

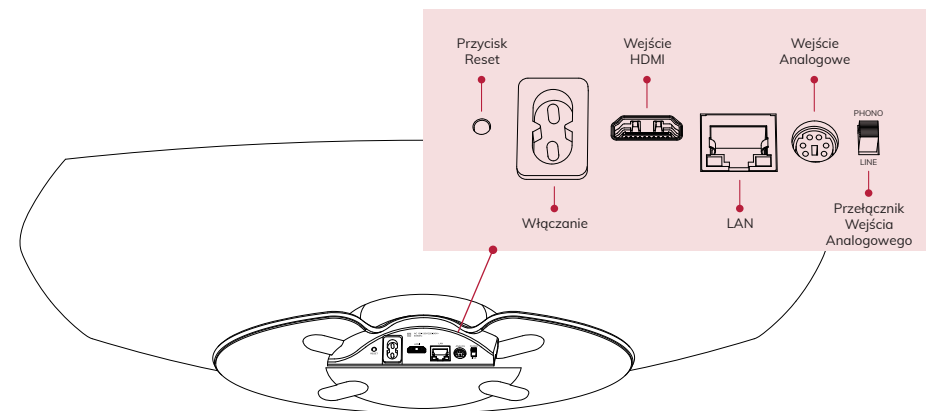

4 POCZĄTEK

4.1

Ustaw Omnia w miejscu, w którym chcesz ją używać i podłącz kabel zasilający.

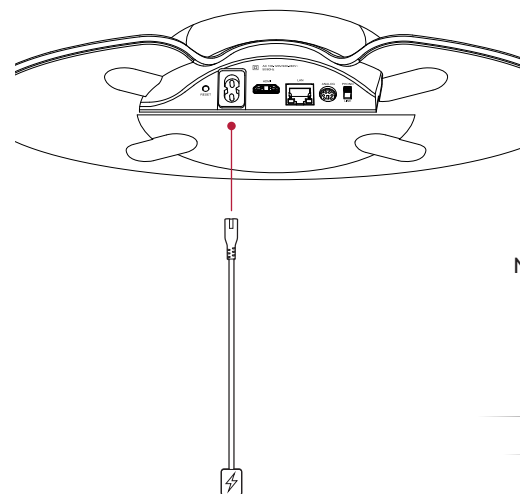

4.2

Naciśnij Linie Kontrolną (On/Off).

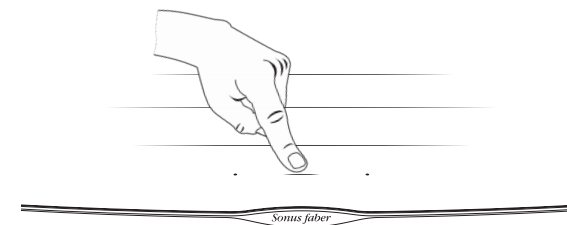

5 KONFIGURACJA

Kiedy Linia Kontrolna (Play/Pauza) miga na biało, głośnik jest gotowy do konfiguracji.

5.1

Urządzenia iOS

Wykorzystanie ustawień Wi-Fi:

- Przejdź do Ustawień i następnie do Wi-Fi
- Wybierz Omnia-xxxxxx w polu Skonfiguruj nowy głośnik AirPlay
- Wybierz sieć Wi-Fi
- Kliknij Dalej i następnie Koniec

Wykorzystanie aplikacji Dom:

- Zainstaluj/zaktualizuj aplikację Dom
- Otwórz aplikację Dom
- Kliknij Dodaj akcesorium
- ŚLEDŹ procedurę ustawienia Wi-Fi

5.2

Urządzenia Android™

- Zainstaluj/zaktualizuj aplikację Google Home
- Otwórz aplikację Google Home
- Kliknij głośnik
- ŚLEDŹ procedurę ustawienia Wi-Fi

Zanotuj: Omnia i Twoje urządzenie muszą być podłączone do tej samej sieci Wi-Fi. Omnia obsługuje oba pasma Wi-Fi, 2,4 Ghz i 5,2Ghz.

5.3

Bluetooth

- Naciśnij przycisk Wejścia na pilocie do momentu, gdy lampka LED Linii Kontrolnej zacznie migać na niebiesko
- Wybierz Omnia-xxxxxx z listy urządzeń bluetooth
- Kiedy niebieska lampka LED Linii Kontrolnej świeci stałym światłem, Omnia jest gotowa do odtwarzania muzyki

5.4

Ethernet

- Podłącz router do Omnia przy pomocy kabla Ethernet

6 SŁUCHAJ MUZYKI

Naciśnij przycisk Wejścia na pilocie w celu zmiany źródła sygnału wejściowego. W odpowiedzi Linia Kontrolna zmieni kolor. Zapoznaj się z instrukcją online w celu uzyskania dalszych informacji. Wybrane wejście wskazane jest kolorem LED Linii Kontrolnej.

- Bluetooth (niebieski)
- HDMI (pomarańczowy) WAŻNE: upewnij się, że wyjście TV jest ustawione na PCM
- Phono (różowy) WAŻNE: upewnij się, że wkładka gramofonowa to moving magnet (MM) z wyjściem sygnału zawartym między 2,4mV a 5,0mV
- Aplikacja dla streaming (biały):
 - AirPlay (biały)*
 - Chromecast built-in (żółty)*
 - Spotify (zielony)*
 - Roon (fioletowy)*
 - Tidal (błękitny/turkusowy)*

* Po podłączeniu aplikacji streaming użytkownika, dany kolor pojawi się na Linii Kontrolnej Omnia.

1 СОДЕРЖИМОЕ УПАКОВКИ

1.1

Зарегистрируйте устройство Omnia на сайте sonusfaber.com, и вы получите дополнительную гарантию сроком на 1 год!

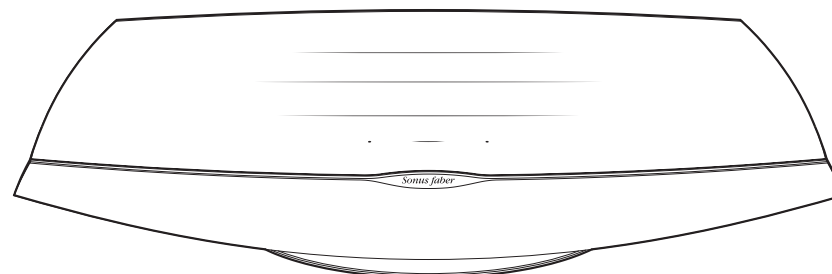

Динамик

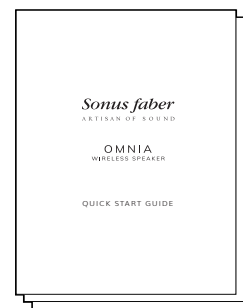

Документация

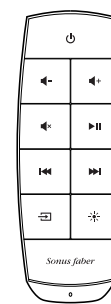

Пульт дистанционного управления



Защитный чехол

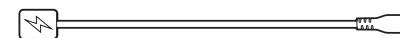

Кабели питания

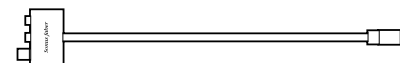

Переходник для входного разъема проигрывателя/линии сервисов

2 КОМАНДЫ

2.1 Динамик

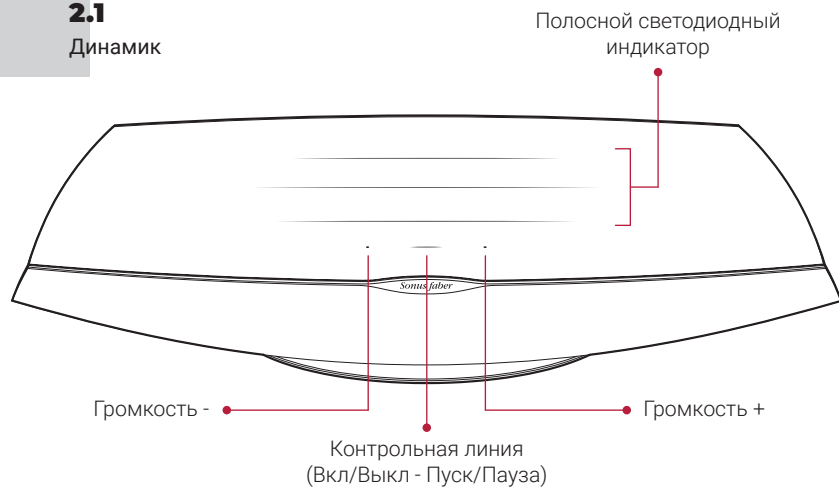

2.2 Пульт дистанционного управления



3 ВВОДЫ И РАЗЪЕМЫ

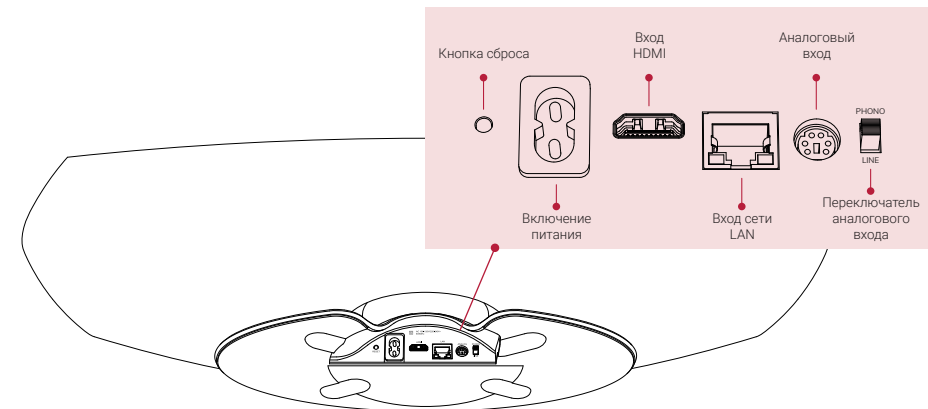

4 НАЧАЛО

4.1

Разместите устройство Omnia в месте использования и подсоедините кабель питания.

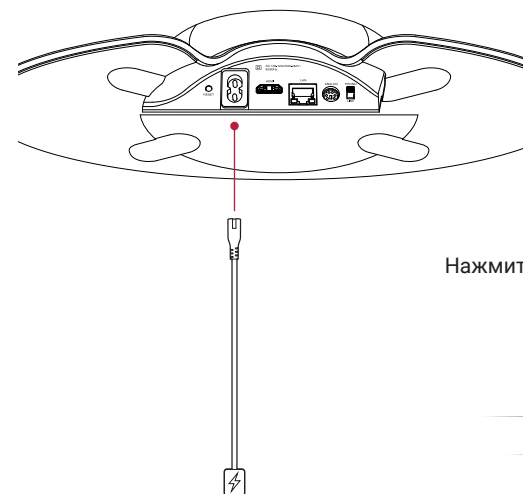

4.2

Нажмите на кнопку контрольной линии (Вкл/Выкл).

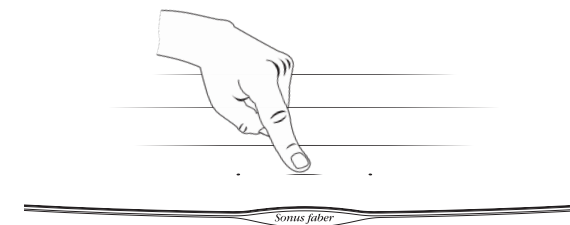

5 КОНФИГУРАЦИЯ

Когда контрольная линия (Пуск/Пауза) мигает белым цветом, динамик готов к выполнению конфигурации.

5.1

Устройства iOS

- При использовании настроек Wi-Fi**
- Зайдите в «Настройки», а затем в Wi-Fi
 - Выберите Omnia-xxxxxx в «Конфигурация нового громкоговорителя AirPlay»
 - Выберите сеть Wi-Fi для подключения
 - Нажмите на «Далее», а затем на «Сделано»

При использовании приложения ДОМ

- Установите/Обновите приложение «Дом»
- Откройте приложение «Дом»
- Нажмите на кнопку «Добавить принадлежность»
- Следуйте процедуре настройки сети Wi-Fi

5.2

Устройства Android™

- Установите/Обновите приложение Google Home
- Откройте приложение Google Home
- Нажмите на кнопку «Динамик»
- Следуйте процедуре настройки сети Wi-Fi

Внимание! Устройство Omnia и ваше устройство должны быть подключены к одной и той же беспроводной сети Wi-Fi. Omnia поддерживает оба канала Wi-Fi с диапазоном 2,4 ГГц и 5,2 ГГц.

5.3

Bluetooth

- Удерживайте нажатой кнопку «Входные сигналы» на пульте дистанционного управления до загорания светодиода контрольной линии мигающим синим цветом
- Выберите Omnia-xxxxxx из списка устройств bluetooth
- Когда синий светодиод контрольной линии загорается немигающим светом, устройство Omnia готово к воспроизведению вашей музыки

5.4

Сеть Ethernet

- Подсоедините маршрутизатор к устройству Omnia при помощи кабеля сети Ethernet

6 ПРОСЛУШИВАНИЕ МУЗЫКИ

Нажмите кнопку «Входные сигналы» на пульте дистанционного управления, чтобы изменить источник входного сигнала. В качестве ответной реакции контрольная линия изменит цвет. Для получения дополнительной информации обращайтесь к руководству онлайн. Выбранный входной сигнал обозначается включением соответствующего цвета светодиодного индикатора контрольной линии.

- Bluetooth (синий)
- HDMI (оранжевый) **ВАЖНАЯ ИНФОРМАЦИЯ:** проверьте, что выход ТВ установлен на PCM
- Проигрыватель (розовый) **ВАЖНАЯ ИНФОРМАЦИЯ:** проверьте, что головка звукоснимателя имеет подвижный магнит (ММ) с выходным сигналом, находящимся в диапазоне от 2,4 мВ до 5,0 мВ
- Приложения для сервисов (белый):
 - AirPlay (белый)*
 - Встроенный Chromecast (желтый)*
 - Spotify (зеленый)*
 - Roon (фиолетовый)*
 - Tidal (голубой/бирюзовый)*

* После подключения пользователем приложения потоковой трансляции контрольная линия устройства Omnia высветится соответствующим цветом.

1 包装内含物品

1.1

到 sonusfaber.com 上注册您的 Omnia, 将额外获得一年的保修!

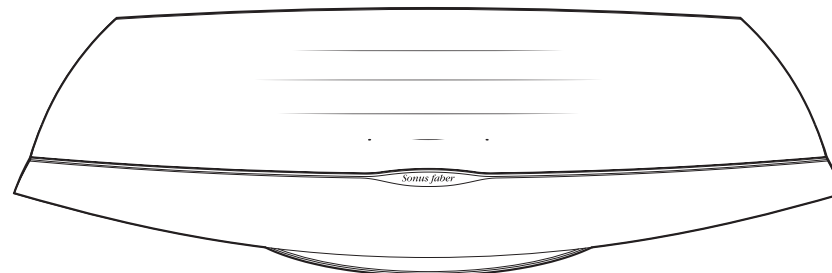

音箱

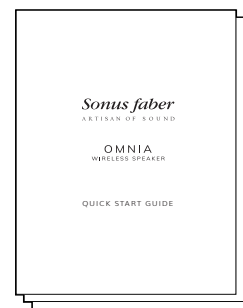

文件

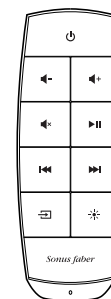

遥控器



保护套

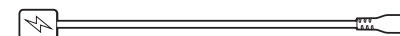

电源线

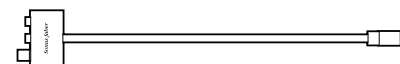

唱机/线路输入适配器

2 控件

2.1 音箱

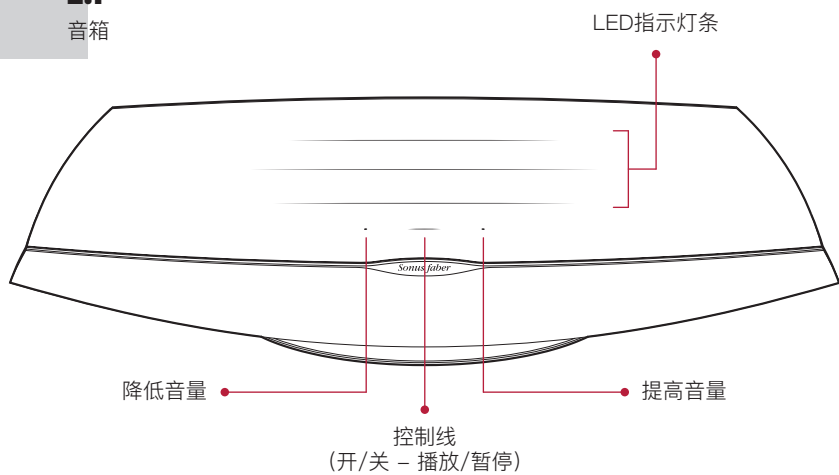

2.2 遥控器

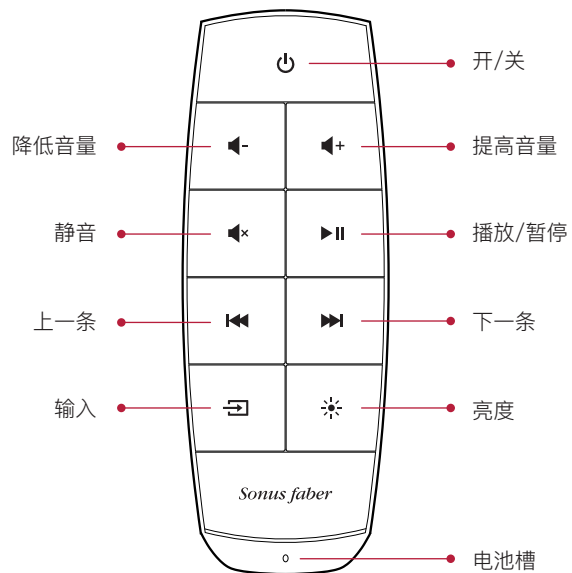

3 输入端

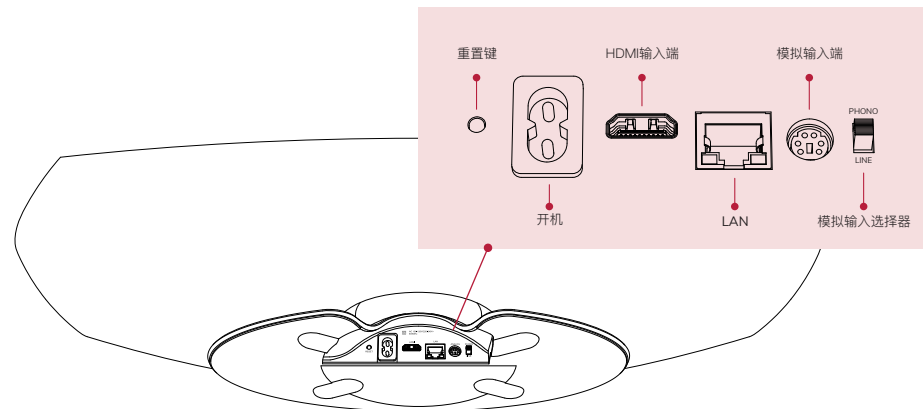

4 开始

4.1

把Omnia放在要使用的地方，然后连接电源线。

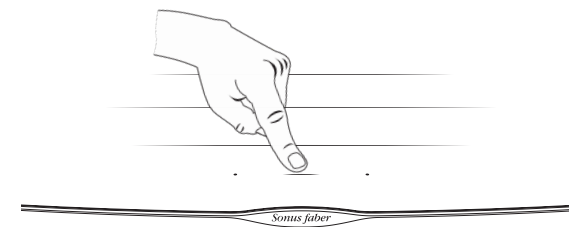
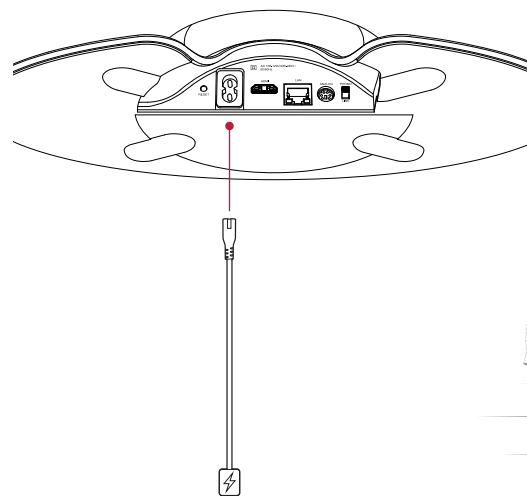

5 设置

当控制线（播放/暂停）闪烁白光时，就可以开始设置音箱了。

5.1 iOS设备

使用Wi-Fi设置

- 前往“设置”，然后选择“Wi-Fi”
- 在“配置新的AirPlay音箱”中选择Omnia-xxxxxx
- 选择要连接的Wi-Fi网络
- 点击“下一步”，再点击“完成”

使用应用程序“家庭”

- 安装/更新应用程序“家庭”
- 打开应用程序“家庭”
- 点击“添加一个新配件”
- 完成设置Wi-Fi的步骤

5.2

Android™设备

- 安装/更新应用程序Google Home
- 打开应用程序Google Home
- 点击“扬声器”
- 完成设置Wi-Fi的步骤

注意：Omnia和您的设备都应连接到同一个Wi-Fi网络。Omnia可支持2.4Ghz和5.2Ghz的Wi-Fi频段。

5.3

蓝牙

- 按住遥控器上的“输入”按钮，直至控制线的蓝色LED灯亮起并闪烁。
- 从蓝牙设备列表中选择Omnia-xxxxxx。
- 当控制线的蓝色LED灯变为长亮时，Omnia就已连接，可以播放您的音乐了。

5.4

以太网

- 用以太网线将路由器连接到Omnia

6 欣赏你的音乐

点击遥控器上的“输入”按钮以更改输入源。控制线将变色表示反馈。参考在线手册了解更多详情。控制线的LED灯颜色将指示选定的输入源。

- 蓝牙（蓝色）
- HDMI（橙色）重要注意事项：请确保电视的输出端设置为PCM
- 唱机（粉红色）重要注意事项：请确保唱机唱头为动磁式（MM），信号输出在2.4mV和5.0mV之间。
- 流媒体应用程序（白色）
 - AirPlay（白色）*
 - 内置Chromecast（黄色）*
 - Spotify（绿色）*
 - Roon（紫色）*
 - Tidal（蓝色/土耳其蓝）*

* 用户连接了流媒体播放App时，Omnia的控制线上会显示相应的颜色。

1 포장 구성

1.1

Sonusfaber.com에 Omnia를 등록하면 1년 추가 보증 혜택을 받으실 수 있습니다!

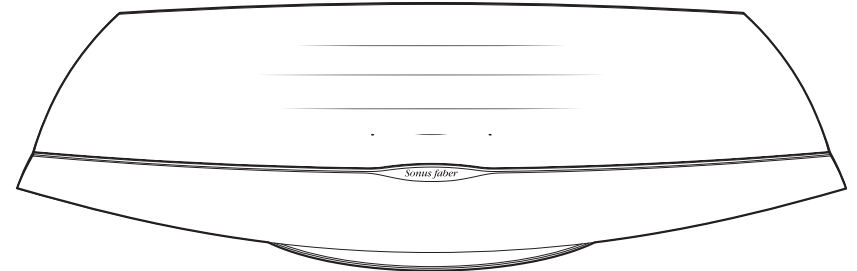

스피커

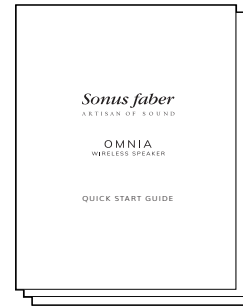

설명서

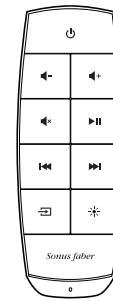

리모컨



보호 케이스

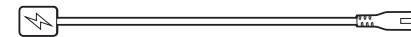

전원 케이블

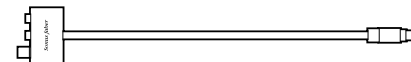

포노/라인 입력 어댑터

2 제어

2.1 스피커

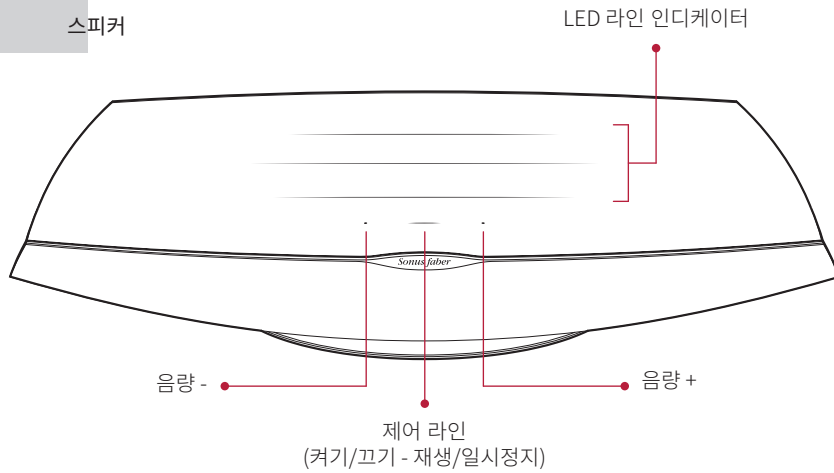

2.2 리모컨

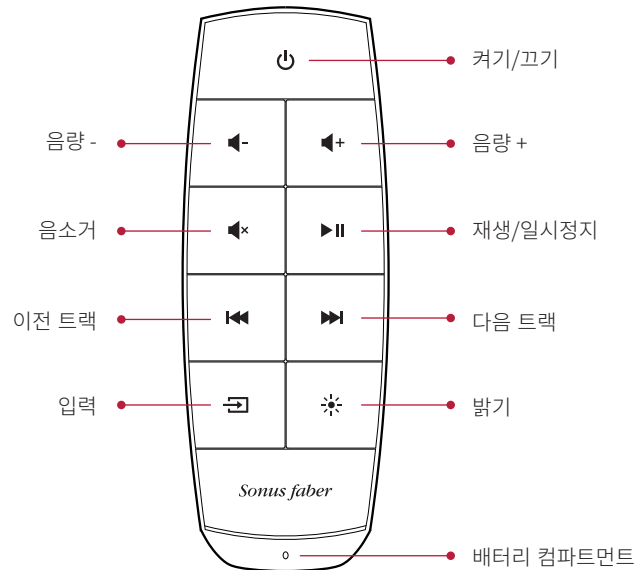

3 입력

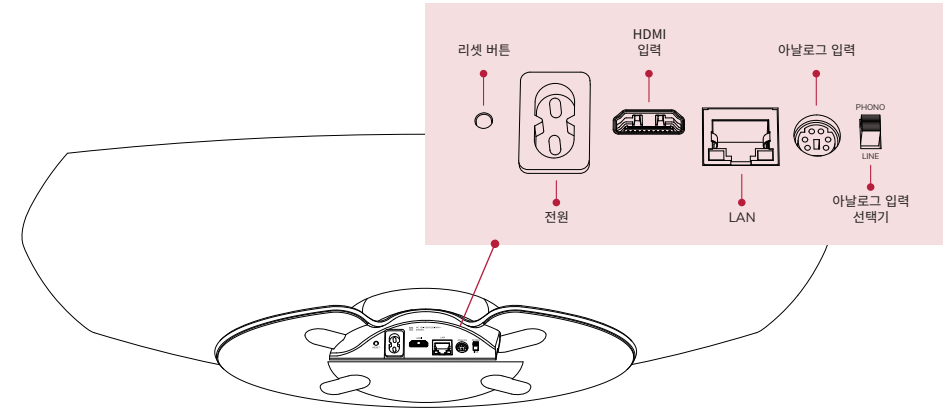

4 시작

4.1

사용하려는 위치에 Omnia를 놓고 전원 케이블을 연결하십시오.

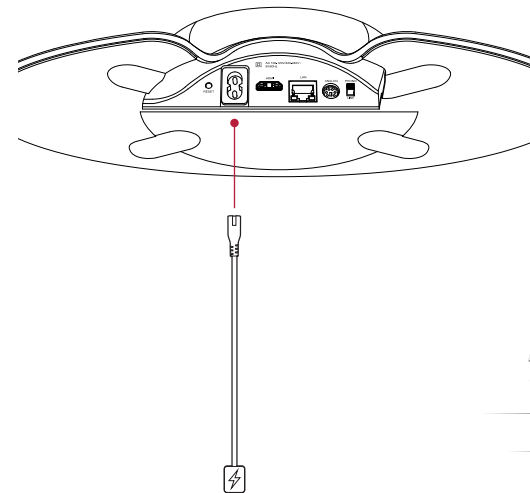

4.2

제어 라인(켜짐/꺼짐)을 누르십시오

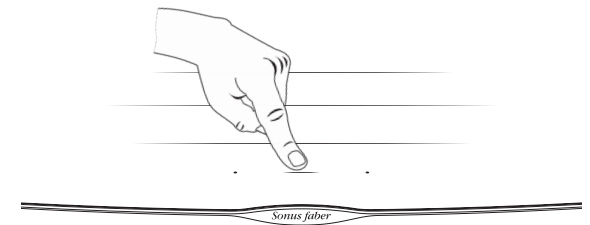

5 구성

"제어 라인(재생/일시정지)이 흰색으로 깜박이면, 스피커를 구성할 준비가 된 것입니다.

5.1 iOS 장치

Wi-Fi 설정 사용

- '설정'으로 이동한 후 'Wi-Fi'로 이동합니다
- '새 AirPlay 스피커 구성'에서 Omnia-xxxxx를 선택합니다
- 연결할 Wi-Fi 네트워크를 선택합니다
- '다음'을 클릭하고 '완료'를 클릭합니다

홈 앱 사용

- 홈 앱을 설치/업데이트하십시오
- 홈 앱을 여십시오
- '액세서리 추가'를 클릭하십시오
- 순서에 따라 Wi-Fi를 설정하십시오

5.2 Android™ 장치

- Google Home 앱을 설치/업데이트하십시오
- Google Home 앱을 여십시오
- 스피커를 클릭하십시오
- 순서에 따라 Wi-Fi를 설정하십시오

주의: Omnia 및 사용자의 장치가 동일한 Wi-Fi에 연결되어 있어야 합니다." Omnia는 2.4Ghz와 5.2Ghz 와이파이 대역을 모두 지원합니다.

5.3 블루투스

- 제어 라인의 LED가 파란색으로 깜박일 때까지 리모컨의 입력 버튼을 누르십시오
- 블루투스 기기 목록에서 Omnia-xxxxx를 선택하십시오
- 제어 라인의 파란색 LED가 고정되면, Omnia를 통해 음악 재생을 시작할 수 있습니다

5.4 이더넷

- 이더넷 케이블로 라우터를 Omnia에 연결하십시오

6 음악 재생

리모컨의 입력 버튼을 눌러 입력 소스를 변경하십시오. 제어 라인의 색상이 변하면서 피드백을 줍니다. 더 자세한 내용은 온라인 설명서를 참조하십시오. 선택된 입력이 제어 라인에 LED 색상으로 표시되고.

- Bluetooth (파란색)
- HDMI(주황색) 중요: TV 출력이 PCM으로 설정되어 있는지 확인하십시오
- 포노(분홍색) 중요: 포노 카트리지가 2.4mV ~ 5.0mV 출력의 이동 자석(MM)인지 확인하십시오
- 스트리밍 앱 (흰색):
 - AirPlay (흰색)*
 - 내장된 Chromecast (노란색)*
 - Spotify (녹색)*
 - Roon (자주색)*
 - Tidal (연푸른색/청록색)*

* 사용자의 스트리밍 앱이 연결되면, Omnia의 제어 라인에 해당 색상이 표시됩니다.

NOTA BENE: Conserva l'imballo originale di Omnia per eventuali futuri trasporti. Per la pulizia di Omnia, usa un panno morbido eventualmente Appena inumidito dopo averlo scollegato.

NOTA BENE: Keep the original Omnia packaging for future transport. Clean Omnia after disconnection using a slightly damp soft cloth.

N.B. Conservez l'emballage d'origine d'Omnia pour tout transport futur. Pour nettoyer Omnia, utilisez un chiffon doux éventuellement légèrement humidifié après avoir déconnecté l'Appareil.

BITTE BEACHTEN: Bewahren Sie die Originalverpackung des Omnia für eventuelle zukünftige Transporte auf. Um Ihren Omnia zu reinigen, verwenden Sie ein weiches, leicht feuchtes Tuch, nachdem Sie ihn vom Stromnetz getrennt haben.

NOTA: Se recomienda guardar el embalaje original de Omnia para futuros transportes. Para limpiar Omnia, desconectarlo y utilizar un paño suave y apenas humedecido.

OBSERVAÇÃO: Guarde a embalagem original Omnia para eventuais transportes futuros. Para a limpeza de Omnia, use um pano macio eventualmente humedecido, depois de desconectá-lo.

NOTA BENE: Bewaar de originele verpakking voor eventueel later transport. Reinig Omnia met een zachte en eventueel licht bevochtigde doek na het Apparaat te hebben afgekoppeld.

ZANOTUJ: Zachowaj oryginalne opakowanie Omnia dla ewentualnych przyszłych transportów. Dla czyszczenia Omnia, po odłączeniu, użyj miękkiej szmatki, ewentualnie lekko zwilżonej.

ВНИМАНИЕ!

Сохраните оригинальную упаковку устройства Omnia для возможных транспортировок в будущем. Для очистки устройства Omnia используйте мягкую слегка увлажненную ткань, предварительно отсоединив его от источника питания.

注意

请妥善保管Omnia的原包装, 以便将来需要运输时使用。清洁Omnia时, 需先断开电源, 然后用一块柔软抹布擦拭, 必要时可以沾少量的水。

주의:

나중에 이동할 때를 위해 Omnia의 원래 포장을 잘 보관하십시오. 청소할 때는, Omnia의 전원 연결을 해제한 후 약간 촉촉한 부드러운 천을 사용하십시오.

TRADEMARK AND LICENCE

The Sonus faber Omnia incorporates copyright protected technology that is protected by Italian patents and other Intellectual property rights. The Sonus faber Omnia uses the following Technologies:



Use of the Works with Apple badge means that an accessory has been designed to work specifically with the technology identified in the badge and has been certified by the developer to meet Apple performance standards. Apple, iPad, iPad Air, iPad Pro, iPhone and AirPlay are trademarks of Apple Inc., registered in the U.S. and other countries. To control this AirPlay 2–enab speaker, iOS 11.4 or later is required.

Chromecast built-in™

Google, Android, Google Home and Chromecast built-in are trademarks of Google LLC.



Being Roon Ready means that Sonus faber uses Roon streaming technology, for an incredible user interface, simple setup, rock-solid daily reliability, and the highest levels of audio performance, without compromise.



Use your phone, tablet or computer as a remote control for Spotify.

Go to spotify.com/connect to learn how.

The Spotify Software is subject to third party licenses found here: www.spotify.com/connect/third-party-licenses



High Fidelity Music Streaming



The Bluetooth® word mark and logos are registered trademarks owned by Bluetooth SIG, Inc. and any use of such marks by Sonus faber, is under license. Other trademarks and trade names are those of their respective owners.



The Wi-Fi CERTIFIED logo is a registered trademark of the Wi-Fi Alliance. Wi-Fi CERTIFIED Logo indicates the product has undergone rigorous testing by Wi-Fi Alliance and has demonstrated interoperability with other products, including those from other companies that bear the Wi-Fi CERTIFIED Logo.



Qualcomm aptX is a product of Qualcomm Technologies, Inc. and/or its subsidiaries. Qualcomm is a trademark of Qualcomm Incorporated, registered in the United States and other countries. aptX is a trademark of Qualcomm Technologies International, Ltd., registered in the United States and other countries.



The terms HDMI®, HDMI High-Definition Multimedia Interface, and the HDMI Logo are trademarks or registered trademarks of HDMI Licensing Administrator, Inc.

NOTE
