



SONANCE®

# SONAMP MULTI-CHANNEL POWER AMPLIFIER WITH SonARC V2

## INSTRUCTION MANUAL

---

DSP 2-150 MKII

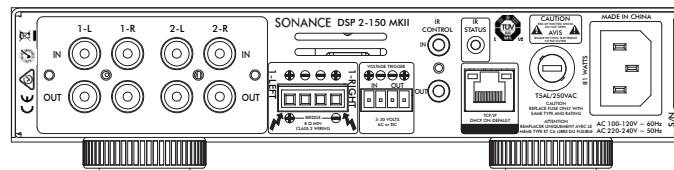
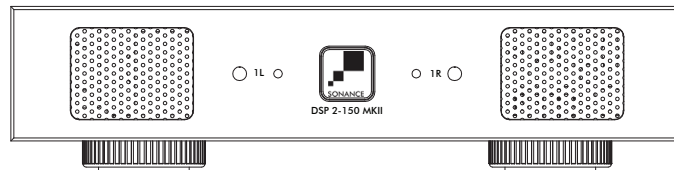

# TABLE OF CONTENTS

Safety	2
Introduction/Box Contents	3
Front Panel/Rear Panel	4
Amplifier Power Requirements	6
Connections & Volume Level Controls	7
Protection Circuitry & LEDs/Stacking	8
Network Connection Instructions	9
Basic Setup	9
Advanced Setup	10
Specifications	15
Appendix A & B	16
Troubleshooting	17
Warranty	19

# IMPORTANT SAFETY INFORMATION

**IMPORTANT: READ ALL OF THESE INSTRUCTIONS BEFORE YOU INSTALL OR OPERATE YOUR SUBWOOFER AND SAVE THESE INSTRUCTIONS FOR LATER USE.**

- 1. Read Instructions** — All these safety and operating instructions should be read before you operate the unit.
- 2. Retain Instructions** — These safety and operating instructions should be retained for future reference.
- 3. Heed Warnings** — All warnings on the unit and in the operating instructions should be adhered to.
- 4. Follow Instructions** — All operating and use instructions should be followed.
- 5. Water and Moisture** — The unit should not be used near water — for example, near a bathtub, washbowl, kitchen sink, in a wet basement, or near a swimming pool, etc.
- 6. Carts and Stands** — The unit should be used only with a cart or stand that is recommended by the manufacturer. A unit and cart combination should be moved with care. Quick stops, excessive force, and uneven surfaces may cause the unit and cart combination to overturn.



**7. CAUTION: To prevent electric shock, do not use the subwoofer's polarized plug with an extension cord, receptacle, or other outlets unless the blades can be fully inserted to prevent blade exposure.**

- 8. Ventilation** — The unit should be situated so that its location or position does not interfere with its proper ventilation. For example, the unit should not be placed in a built-in installation, such as a bookcase or cabinet, that may impede the flow of air over the back plate.
- 9. Heat** — The unit should be situated away from heat sources such as radiators, heat registers, stoves, or other appliances (including other audio components) that produce heat.

- 10. Power Sources** — The unit should be connected to a power supply only of the type described in the operating instructions or as marked on the unit.
- 11. Accessories and Attachments** — Only use accessories and attachments specified by the manufacturer.
- 12. Grounding or Polarization** — Precautions should be taken so that the grounding or polarization means of the unit is not defeated.
- 13. Power Cord Protection** — Power cords should be routed so that they are not likely to be walked on or pinched by items placed upon or against them, paying particular attention to cords at plugs, convenience receptacles, and the point where they exit from the controller.
- 14. Cleaning** — The unit should be cleaned only as recommended by the manufacturer.
- 15. Non-Use Periods** — The power cord of the unit should be unplugged from the outlet when left unused for a long period of time.
- 16. Object and Liquid Entry** — Care should be taken so that objects do not fall and liquids are not spilled into the enclosure through openings.
- 17. Damage Requiring Service** — The unit should be serviced by qualified service personnel when:
  - The power cord or the plug has been damaged.
  - Objects have fallen or liquid has been spilled into the unit.
  - The unit has been exposed to rain.
  - The unit does not appear to operate normally or exhibits a marked change in performance.
  - The unit has been dropped or the enclosure damaged.
- 18. Servicing** — The user should not attempt to service the unit beyond that described in the operating instructions. All other servicing should be referred to qualified service personnel.



The lightning flash with arrowhead symbol, within an equilateral triangle, is intended to alert the user to the presence of uninsulated dangerous voltage within the product's enclosure that may be of sufficient magnitude to constitute a risk of electric shock to persons.



The exclamation point within an equilateral triangle is intended to alert the user to the presence of important operating and maintenance (servicing) instructions in the literature accompanying the appliance.



In accordance with the European Union WEEE (Waste Electrical and Electronic Equipment) directive effective August 13, 2005, we would like to notify you that this product may contain regulated materials which upon disposal, according to the WEEE directive, require special reuse and recycling processing. For this reason Sonance has arranged with our distributors in European Union member nations to collect and recycle this product at no cost to you. To find your local distributor please contact the dealer from whom you purchased this product. Please note, only this product itself falls under the WEEE directive. When disposing of packaging and other related shipping materials we encourage you to recycle these items through the normal channels.



**DSP 2-150 MKII  
Amplifier**

Tested to comply with FCC Standards for home or office use only.

This device complies with part 15 of the FCC Rules. Operation is subject to the following two conditions:

- (1) This device may not cause harmful interference
- (2) This device must accept any interference received, including interference that may cause undesired operation.

# Introduction

Thank you for purchasing the Sonance Sonamp DSP 2-150 MKII amplifier. When properly installed, this amplifier will give you many years of entertainment pleasure. To get the most out of your new amplifier, please read this manual thoroughly before you begin installation.

To achieve the best performance, Sonance recommends that this amplifier be installed by a Sonance Authorized Dealer/Installer.

### Box Contents

- (1) Instruction manual
- (1) Network connection instructions
- (1) Sonamp DSP 2-150 MKII amplifier
- (1) IEC power cord
- (4) Removable rubber feet
- (2) Long rack ears

# Unpacking

Save the carton and polystyrene inserts for future safe transport in case the amplifier is moved or requires shipping for repair. Before proceeding with installation, locate the serial number on the rear panel of the unit and note it here for future reference: S/N: \_\_\_\_\_.

# Placement

Place the amplifier on a level surface, in an upright position, out of direct sunlight and away from windows through which rain may enter. Situate the amplifier away from heat sources such as hot air ducts or radiators. Be sure that the amplifier is adequately ventilated by convection or suitable cabinet fans.

- Never place any object on or against the amplifier.
- Never operate the amplifier on a carpeted surface as this will compromise ventilation.
- When the amplifier is installed in any cabinet, the front or back must be open during operation. Alternately, install fans in the cabinet to assure continuous ventilation.

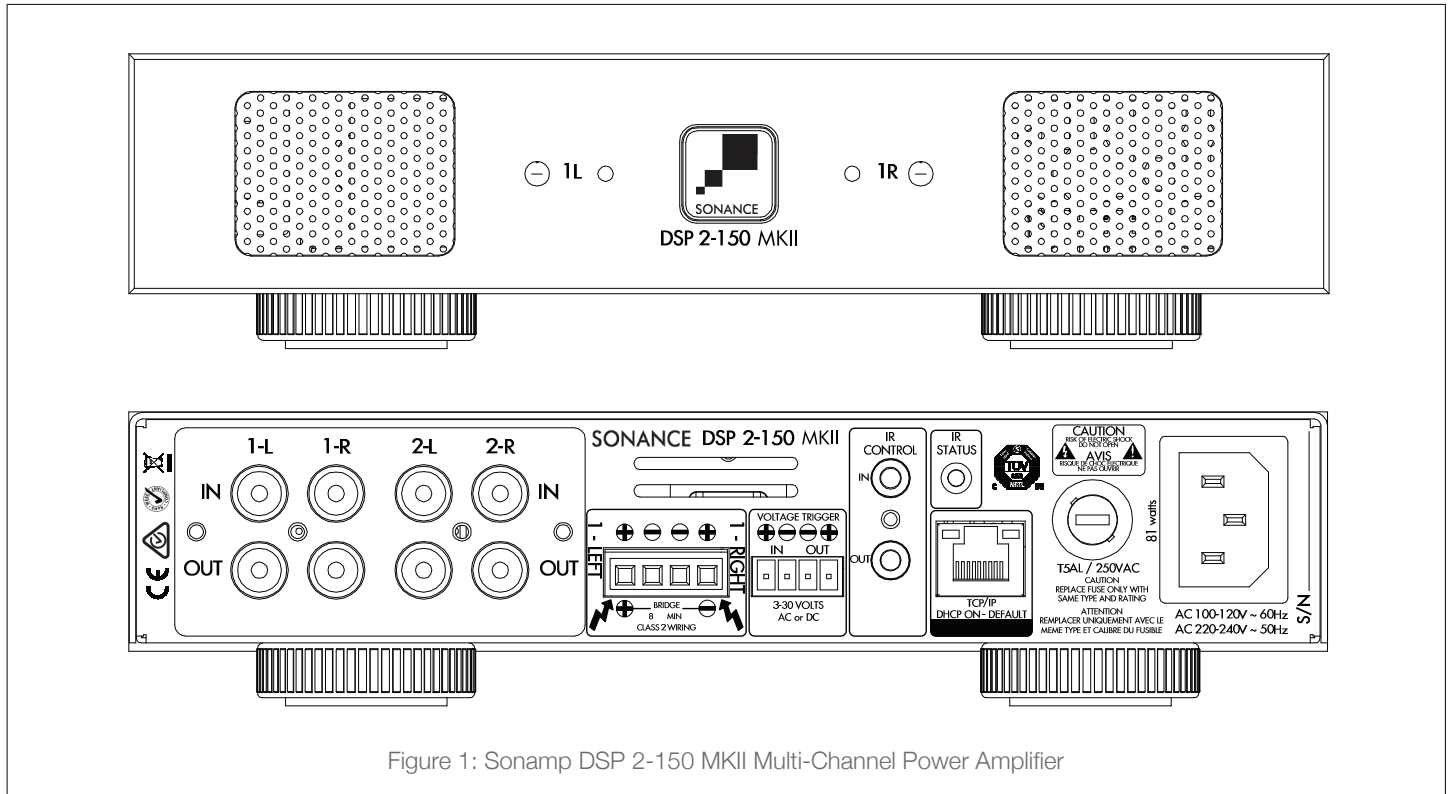

Figure 1: Sonamp DSP 2-150 MKII Multi-Channel Power Amplifier

## DSP 2-150 MKII Front Panel

1. Illuminated Power Button
2. Power, Active & Protection Indicator LED
3. Recessed Volume Level Control

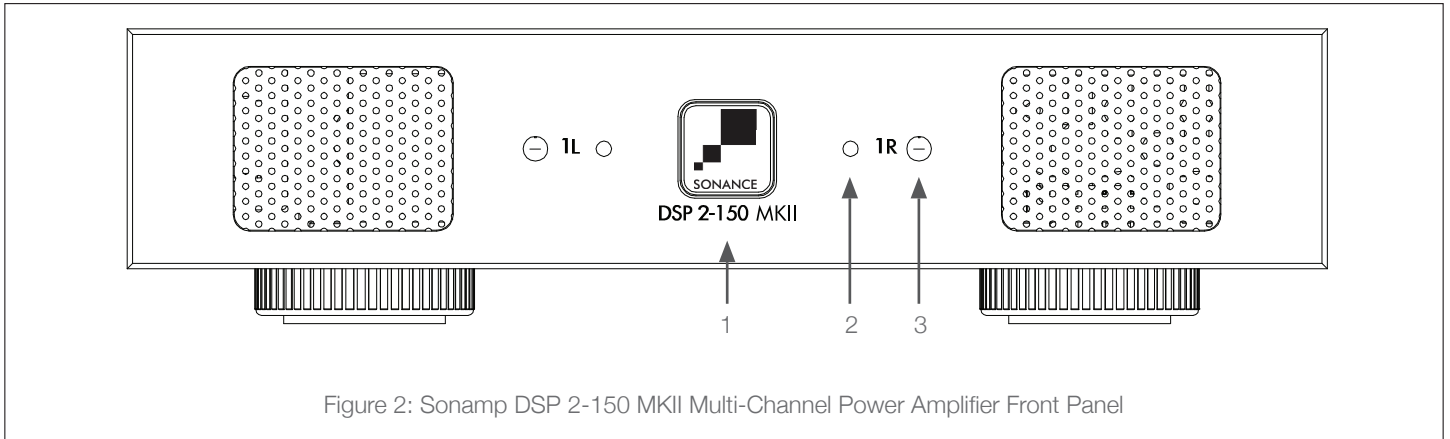

Figure 2: Sonamp DSP 2-150 MKII Multi-Channel Power Amplifier Front Panel

## DSP 2-150 MKII Rear Panel

4. Analog Input/Out Card (L/R Line In, Loop Outputs)
5. Speaker Block Connector
6. Trigger Input/Output Connector
7. IR Control In/Out
8. IR Status Light
9. RJ-45 Input
10. AC Fuse Holder
11. Power Cord Connection

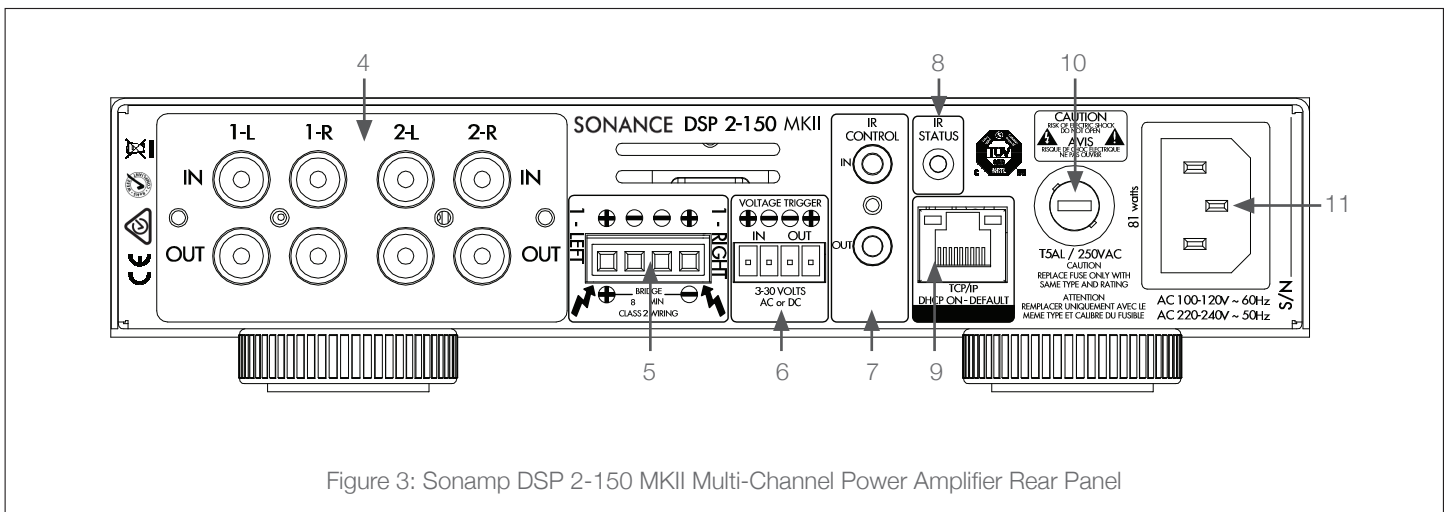

Figure 3: Sonamp DSP 2-150 MKII Multi-Channel Power Amplifier Rear Panel

**NOTE: L/R LINE IN/LOOP OUTPUT CARD CAN BE REPLACED WITH SONANCE DIGITAL INPUT MODULE (SKU 93099 SOLD SEPARATELY) FOR ULTIMATE PERFORMANCE ENHANCEMENT THROUGH DIRECT CONNECTION TO A DIGITAL SOURCE.**

# Front Panel

## Power Button

The power button turns the amplifier on and off. When the Sonance logo power button is engaged, the power button is illuminated solid white. This means the amplifier has power and is turned ON and ready to operate. When the Sonance logo button is slightly dimmed, the amplifier is in standby mode. When the Sonance logo button blinks white, the amplifier power supply is in thermal protection. In this situation, the channel LEDs will also illuminate red, indicating that the power supply is in thermal protection mode.

**NOTE: UPON INITIAL POWER UP, THERE WILL BE A 9-12 SECOND DELAY BEFORE SOUND IS HEARD DURING THE BOOT UP CYCLE. THE INDICATOR LEDS WILL ILLUMINATE RED, THEN GREEN, THEN GO OUT. THIS IS NORMAL.**

## Input/Output Lights

When each channel is active, the LED will light green as long as a signal is present. Input/Output LEDs blinking red indicate that the associated channel is being over-driven. Input/Output LEDs turning solid red indicate that the amplifier is in protect mode. While in protect mode the LED lights will periodically light green to retest the output to determine if the issue has been resolved. Protect mode could be caused by a short in the wire, overheating of the amplifier or other internal problem with the amplifier.

**NOTE: WHEN ANY OF THE LEDS ARE RED, TURN THE AMPLIFIER OFF IMMEDIATELY. DETERMINE THE CAUSE OF THE PROBLEM BEFORE TURNING THE AMPLIFIER BACK ON.**

## Volume Level Control

Each channel on the amplifier has volume adjustments controlled in the SonARC software or on the front panel recessed volume controls. Output volume will reflect the option last adjusted. The DSP 2-150 MKII amplifier ships at the +12 or maximum volume level.

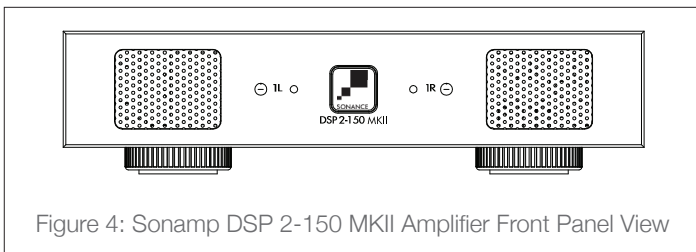

Figure 4: Sonamp DSP 2-150 MKII Amplifier Front Panel View

# Rear Panel

## Line Inputs/Loop Outputs

The DSP 2-150 MKII amplifier has line inputs and loop outputs. The loop outputs are non buffered, the maximum number of amplifiers that can be looped together will depend on the output capability of your source component

## Speaker Connections

The removable block connectors used on the Sonamp amplifiers will accept up to 12 gauge wire. Follow the connection layout on the rear panel of the amplifier. Make sure no bare wires come in contact with the amplifier chassis. When bridging channels, use the two outside connections on each connector. The positive wire from the speaker should be on the left side connection and the negative connection should be on the right side.

## Auto On - Voltage In/Out Trigger

The Sonamp amplifiers can be turned on and off using 3-30 volts AC or DC. The Voltage Output supplies a 12 volt DC signal to control additional amplifiers or other equipment. The included red wire is to prevent the amp from accidentally entering sleep mode during setup. Remove the red wire when using the voltage trigger.

## IR Control

IR control is established via the 3.5mm mono mini input jack on the rear of the amplifier. IR commands include volume, mute, group, power and input options. IR controls global On/Off, group volume, muting and input source selections. Connectivity can be seen with IR status light.

## IP Control

IP control is via the RJ-45 input. IP controls power On/Off, volume, muting and input source selections for either global control or group control.

## AC Fuse Holder

To replace the fuse, unplug the power cord from the Power Cord Connector and use a screwdriver to remove the fuse holder. DSP 2-150 MKII - 5 amp AC.

**CAUTION: FOR CONTINUED PROTECTION AGAINST FIRE, REPLACE THE FUSE WITH ONLY THE SAME TYPE AND RATING.**

## Power Cord

The Sonamp DSP 2-150 MKII features a removable power cord. Plug the female end of the power cord into the Power Cord Connector on the amplifier rear panel and plug the male end into a grounded wall socket.

DO NOT plug the amplifier's power cord into a convenience outlet on any other audio or video component. If you need to use an extension cord, use only a heavy duty (14 GAUGE OR LARGER) extension cord to avoid starving the amplifier of the current necessary for full operation.

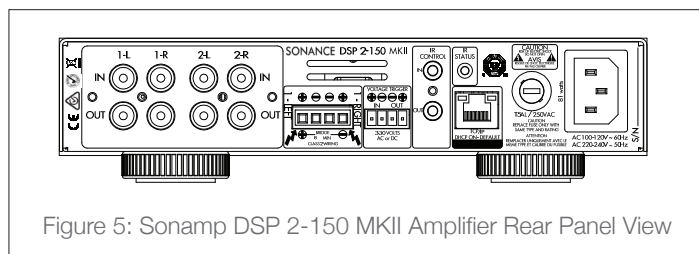

Figure 5: Sonamp DSP 2-150 MKII Amplifier Rear Panel View

## Powering the Amplifier

The Sonamp DSP 2-150 MKII features a removable IEC power cord (see Figure 6). A 14 gauge EIA standard 120 volt grounded power cable is included with the amplifier. Each time the amplifier's power cord is initially plugged in and the POWER switch is turned ON, all channel outputs are disconnected for approximately 9-12 seconds and all PROTECTION LEDs will illuminate briefly while the amp boots up.

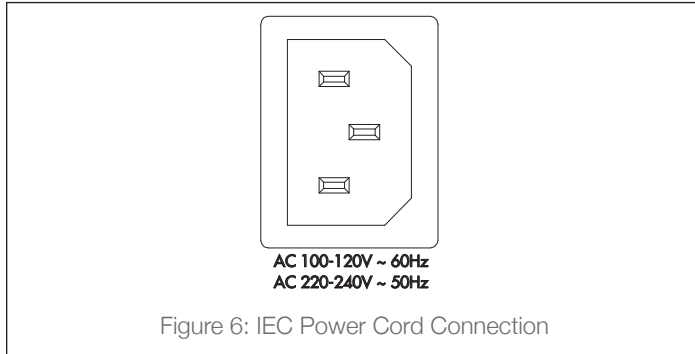

Figure 6: IEC Power Cord Connection

**IMPORTANT: DO NOT PLUG THE POWER CORD INTO THE WALL OUTLET UNTIL ALL SYSTEM CONNECTIONS HAVE BEEN MADE AND VERIFIED.**

Plug the female end of the power cable into the Power Connector on the amplifier's rear panel and plug the male end directly into a grounded 15 amp or 20 amp wall outlet.

**IMPORTANT: DO NOT PLUG THE AMPLIFIER'S POWER CORD INTO A CONVENIENCE OUTLET ON ANY OTHER AUDIO OR VIDEO COMPONENT.**

If the electrical service is subject to frequent sags, spikes or brownouts, a power conditioner designed for use with high fidelity equipment should be employed to protect the amplifier.

**CAUTION: FOR CONTINUED PROTECTION AGAINST FIRE, REPLACE THE FUSE WITH ONLY THE SAME TYPE AND RATING WHEN NECESSARY..**

## Source Connections Selection DSP 2-150 MKII

There are two options when connecting audio inputs to the DSP 2-150 MKII amplifier (see Figure 8):

**Primary Line Inputs 1-L, 1-R:** Use these inputs for primary audio source.

**Secondary Line Inputs 2-L, 2-R:** Use these inputs for a secondary audio source, paging or a doorbell.

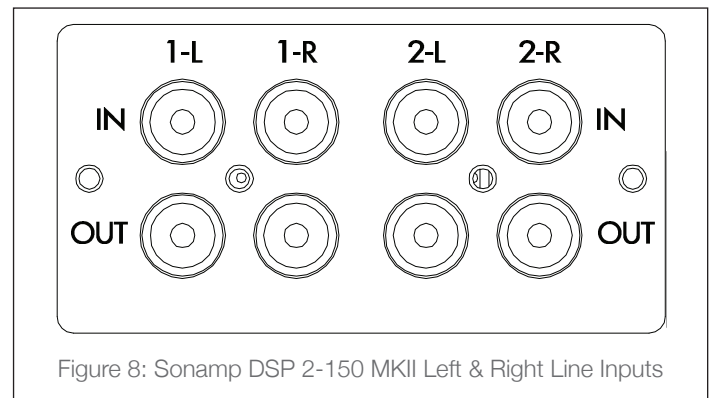

Figure 8: Sonamp DSP 2-150 MKII Left & Right Line Inputs

## Amplifiers Power Requirements:

Model	Input Voltage	Output Power (sinewave)	Draw Watts	15 Amp Breaker Qty of Amplifiers	20 Amp Breaker Qty of Amplifiers
DSP 2-150 MKII	100-120V AC	Full Power All Channels @8 ohms	371	3	5
		Full Power All Channels @4 ohms	392	3	4
		1/8 Power All Channels @8 ohms	72	20	26
		1/8 Power All Channels @4 ohms	74	19	25
		@ Idle	17		
		Sleep Mode	1.5		
		Voltage or Green Audio	0.48		
Model	Input Voltage	Output Power (sinewave)	Draw Watts	13 Amp Breaker Qty of Amplifiers	20 Amp Breaker Qty of Amplifiers
DSP 2-150 MKII	220-240V AC	Full Power All Channels @8 ohms	359	4	5
		Full Power All Channels @4 ohms	376	3	5
		1/8 Power All Channels @8 ohms	69	20	27
		1/8 Power All Channels @4 ohms	71	20	27
		@ Idle	15		
		Sleep Mode	1.1		
		Voltage or Green Audio	0.5		

Figure 7: Sonamp DSP 2-150 MKII Multi-Channel Amplifier Power Requirements

## Speaker Connections

For the best sound you should use premium speaker wire that complies with fire rating codes. Be sure to check local codes governing wire that may be installed within walls or ceilings. Sonamp amplifiers are stable with any reputable brand of speaker wire or cable. The Sonamp amplifiers use speaker block connectors that can accommodate up to 12 gauge wire (see Figure 9).

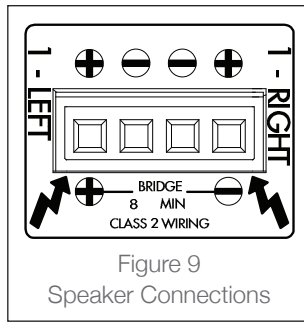

Figure 9  
Speaker Connections

**NOTE: ALWAYS CHECK LOCAL BUILDING CODES BEFORE INSTALLING WIRE IN WALLS OR CEILINGS.**

## Bridging Channels DSP 2-150 MKII

**IMPORTANT: THE MINIMUM SPEAKER IMPEDANCE FOR BRIDGED OPERATION IS 8 OHMS. DO NOT OPERATE A ZONE IN THE BRIDGED MODE INTO A SPEAKER THAT IS LESS THAN 8 OHMS NOMINAL IMPEDANCE.**

Bridging channels is accomplished using the SonARC v2 software. On the second page in the software under IN/OUT Settings, go to the output setup area to bridge mode and make your selections with the drop down buttons.

1. Use the left audio input when operating the amplifiers output in bridge mode (see Figure 10).
2. Select ON in the bridge mode (see figure 10).
3. Connect the speaker's "+" lead to the left side of the connector marked "+" (see Figure 11).
4. Connect the speaker's "-" lead to the right side of the connector marked "+" (see Figure 11).
5. Connect the line level audio input to the LEFT channel input on the amplifier.

OUTPUT SETUP		1 LEFT	1 RIGHT
	Output Name	Output 1L	Output 1R
	Stereo / Mono	Stereo	Stereo
	DSP Preset	FLAT	FLAT
	Output Group	A	A
	Bridge Mode	ON	

Figure 10: Bridging Channels

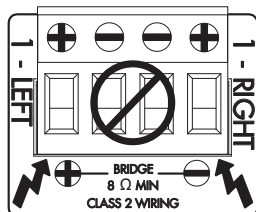

Figure 11: Bridging Channels

## Source Connections DSP 2-150 MKII

On the left side of the rear panel are the audio inputs for the left and right channels. In addition to the left and right inputs there are also loop outputs for each channel. The loop outputs allow multiple amplifiers to share common audio sources. The loop outputs on the amplifiers are not buffered. The number of amplifiers that can be connected in series will depend on the output level of your audio source. The source connected to the LEFT and RIGHT LINE IN Inputs pass through the LEFT and RIGHT LINE Outputs (see Figure 12).

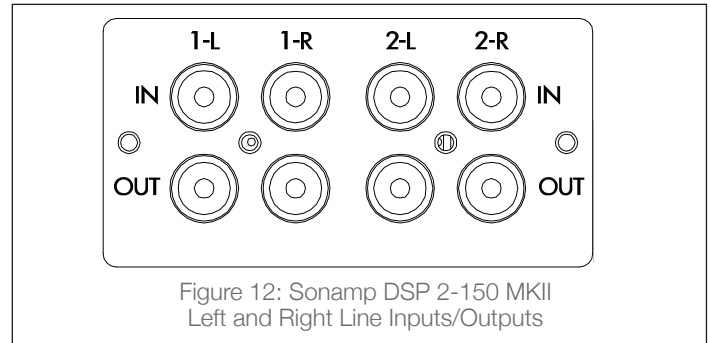

Figure 12: Sonamp DSP 2-150 MKII  
Left and Right Line Inputs/Outputs

## Volume Level Control

Volume can be controlled from the individual recessed volume level control screws, located on the front panel and from SonARC (see Figure 13). These volume controls balance the desired sound levels per channel. Volume can be controlled three different ways with SonARC v2 (see Figure 14).

1. Output volume
2. Turn on volume
3. Maximum volume

Output volume ranges between -70 to 12. The volume level controls are set at +12 by default.

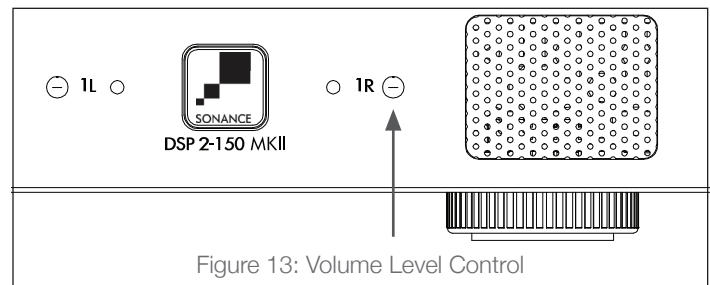

Figure 13: Volume Level Control

OUTPUT VOLUME		1 LEFT	1 RIGHT
	Output Volume	0	0
	Turn On Volume	6	6
	Maximum Volume	12	12
	Gain Offset	0	0
	Mute	OFF	OFF

Figure 14: SonARC Page In/Out Settings Output Volume

**IMPORTANT: USE CAUTION WHEN SETTING VOLUME LEVELS EITHER ON THE AMPLIFIER OR AN AUDIO SWITCHER AS NOT TO OVERDRIVE AND POSSIBLY DAMAGE SPEAKERS. VERIFY ALL SOURCES AS OUTPUT VOLTAGE VARIES FROM DEVICE TO DEVICE.**



## Protection Circuitry and LEDs

The Sonamp amplifiers have a multi-stage protection system to prevent damage to your amplifier and speakers.

### Amplifier Channel Protection DSP 2-150 MKII

If a channel encounters a short-circuit (in bridge mode the protection circuitry will sense a short circuit across both positive speaker terminals), or extremely low impedance will cause the affected channel outputs to automatically mute. The output of the affected channel will remain muted until the fault has been corrected. Only the affected channels output will mute, all other channels will continue to operate normally.

### Amplifier Channel Protection Indication DSP 2-150 MKII

On the front panel of the Sonamp DSP 2-150 MKII amplifiers are dual color LEDs that illuminate to indicate the current operating status of each amplifier channel.

When the LED blinks red this is an indication that the channel is being over driven.

When the LED lights are solid red this is an indication the amplifier is in protect mode. While in protect mode the LED lights will periodically light green to retest the output to determine if the short has been removed. Protect mode could be caused by a short in the wire, overheating of the amplifier or possibly an internal problem with the amplifier.

If the amplifier senses a very low impedance or a short on its outputs, then it will mute its output and the protection LEDs will turn red. The output will remain muted until the fault is cleared. Check the rear panel block connector for shorted wire strands or reduce the number of speakers connected in parallel to the amplifier outputs. Sonance amplifiers are rated for a 4 ohm load or higher, such as two pair of eight ohm speakers.

**IMPORTANT: ALLOWING THE AMPLIFIER TO OPERATE WITH ONE OR MORE CHANNELS IN PROTECT MODE FOR AN EXTENDED PERIOD OF TIME CAN DAMAGE THE AMPLIFIER.**

### Amplifier Power Supply Protection DSP 2-150 MKII

The amplifier also has protection for the power supply. If the power supply heat sink temperature exceeds the design maximum, the protection circuit will activate, disconnecting all channel outputs. This is indicated by a blinking light on the front panel power switch.

**IMPORTANT: ANY TIME THE PROTECTION CIRCUITS ARE TRIGGERED, UNPLUG THE AMPLIFIER'S POWER CORD FROM THE WALL OUTLET BEFORE TROUBLESHOOTING.**

**NOTE: IF SHELF MOUNTING, ATTACH THE FOUR INCLUDED FEET BY SCREWING THEM INTO THE THREADED OPENINGS ON THE BOTTOM CHASSIS. NO TOOL IS REQUIRED.**

## Rack Ear Installation DSP 2-150 MKII

The DSP 2-150 MKII ships with two long rack ears for when the amplifier is to be used alone in a 1U space. Unscrew the four Phillips head screws (M4 x 0.7 pitch x 10mm long) found on each side of the left and right forward section of amplifier. Use these screws to connect the included rack ears to the amplifier (see Figure 15).

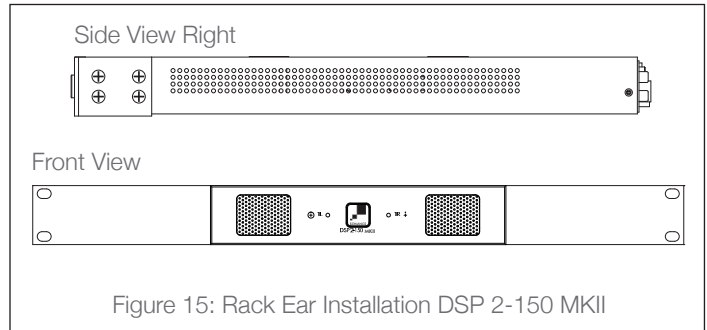

## Amplifier Stacking

The DSP 2-150 MKII is capable of being directly stacked with the feet removed for use in low to moderate output applications (see Figure 16). For high-output applications, it is recommended to leave at least 1U space between amplifiers for increased ventilation. It is not recommended to stack more than three amplifiers high without spacing.

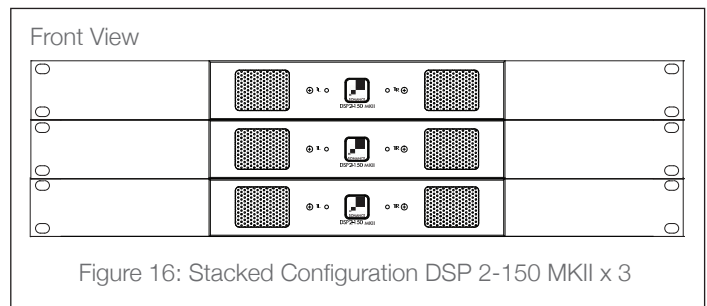

To place two Sonamp 2-100 or DSP 2-150 MKII in a single rack unit order: Rack Mount Bracket for Sonamp 2-100 & DSP 2-150 MKII SKU# 93098 (see Figure 17).

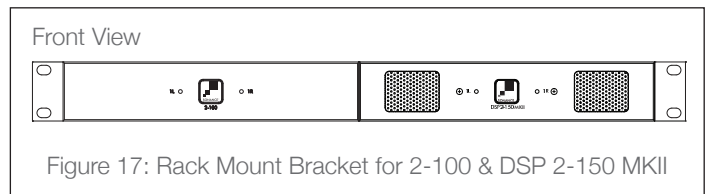

# SonARC Software Network Connection Instructions

## Equipment List

- (1) Computer or tablet
- (1) Network router with DHCP service enabled
- (2) RJ-45 cables (one when using wireless)

## Connecting to Your SonARC Homepage

1. The amplifier's factory default settings has DHCP set to ON.
2. Connect the amplifier to a network with a router. Make sure the computer and amplifier are on the same network.
3. Turn on the amplifier.
4. The amplifier will be issued an IP address by the router.
5. Use an IP scanner to determine the IP address of the Sonance DSP amplifier on the network. We recommend Fing app for IOS, Advanced IP Scanner for Windows devices and LanScan for macOS.
6. Network devices will show up and the amplifier will be named Sonance.
7. Open Safari or Chrome.
8. In the URL address window at the top, enter the IP address of the Sonance DSP amplifier to configure.

## SonARC Legend

Toggle/

Pull-down Menu      Free Type Field      Single Action Menu



## SonARC Homepage

### Setup Options

Your SonARC Homepage will have two options for setup: Basic Setup and Advanced Setup. Amplifier name can be entered by the installer.

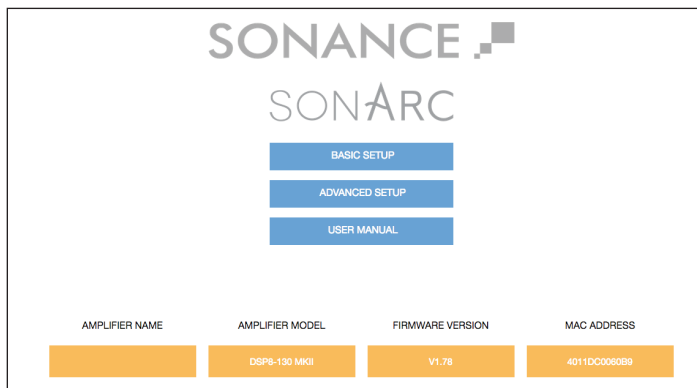

## Basic Setup Page

This page is for basic setup of EQ, source and volume. To start, click on the Basic Setup button.

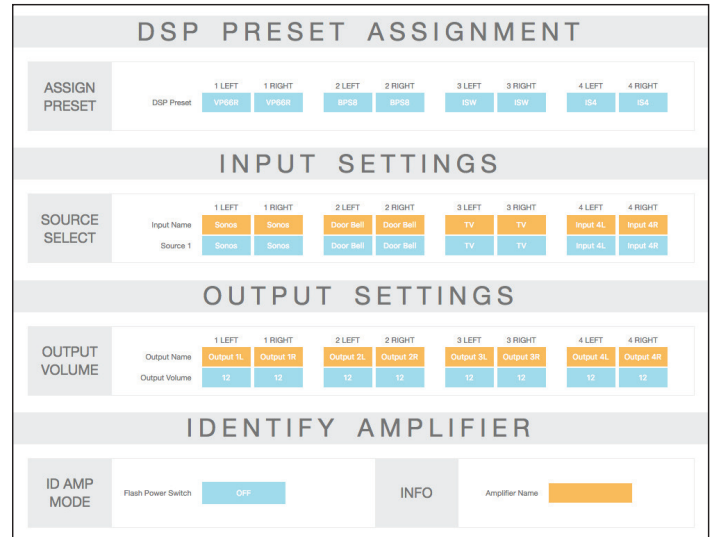
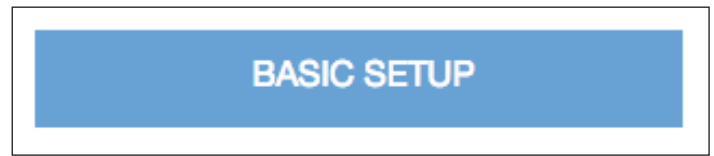

## DSP Preset Assignment

### Assign Preset

Click on the individual channels to show the drop down menu of preset options. Once you locate the preset for your Sonance speakers click on the name to set the preset. Each Sonance DSP amplifier has 50 slots with pre-configured DSP curves for Sonance speaker models pre-loaded. If the speaker model in your application is not on the pre-loaded list, hundreds of DSP files are available for download from the Sonance website. Download the preset file for additional Sonance speaker models at: [www.sonance.com/electronics/amplifiers/dsp](http://www.sonance.com/electronics/amplifiers/dsp).

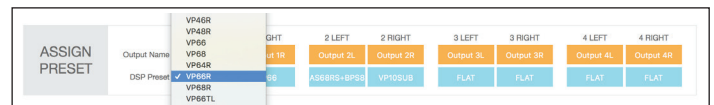

## Input Settings/Source Select

### Input Name

This is a user entered field with a maximum of 15 characters. Use these fields to describe the type of input connected.



### Input Source

This pull down menu allows you to select which input you would like to assign to the channel.

## Output Settings/Output Volume

### Output Name

This is a user entered field with a maximum of 15 characters. Use these fields to describe the room or area the channel will be powering.

OUTPUT VOLUME		1 LEFT	1 RIGHT
	Output Name	Output 1L	Output 1R
	Output Volume	12	12

### Output Volume (Basic Set-Up)

Play music with wide dynamics and bass that will stress the system.

1. Start with the Output Volume for both 1L and 1R set at -30.
2. Slowly increase the volume up towards 12 and listen for any distortion or strain from the speakers. When you hear any distortion, reduce the volume 1 or 2 steps below this value.
3. Set this volume number for both channels. This will provide maximum system performance and protect the speakers from being damaged by amplifier clipping and over-excursion of the woofers.

**NOTE: LEFT AND RIGHT CHANNELS ARE LINKED. OUTPUT VOLUME IS LINKED TO TURN ON VOLUME IN BASIC SETUP.**

## Identify Amplifier

### ID Amp Mode

When the power switch is turned ON, the power button on the front of the amplifier will flash to indicate which amplifier you are programming. This will make the amplifier easy to identify in a multiple amplifier installation.

ID AMP MODE	Flash Power Switch	OFF
-------------	--------------------	-----

### Info

This is a user entered field with a maximum of 15 characters. Use this area to name your MKII.

INFO	Amplifier Name	DSP 8-130 MKII
------	----------------	----------------

The basic setup is complete!

## Advanced Setup Page

This page in SonARC allows you to make advanced changes to the your amplifiers settings and configuration. To start click on the Advanced Setup button from your MKII's homepage.

ADVANCED SETUP
----------------

## General Settings Tab

The Advanced Setup automatically starts out on the General Settings tab. This tab is used to set up your MKII with a network connection, auto on method and other basic information.

General Settings	In/Out Settings	EQ Settings
IP SETUP	IP Address: 192.168.1.2 IP Subnet Mask: 255.255.255.0 DHCP: ON	ID AMP MODE Flash Power Switch: OFF
BACKUP RESTORE	All Settings: RESTORE BACKUP	PRINT Print - All Settings: PRINT
AUTO ON	Auto On Method: Power Button AC Power On Delay: 0 Seconds	
SLEEP MODE	1 LEFT: OFF 1 RIGHT: OFF 2 LEFT: OFF 2 RIGHT: OFF 3 LEFT: OFF 3 RIGHT: OFF 4 LEFT: OFF 4 RIGHT: OFF	
INFO	Amplifier Name: DSP8-130 MKII Amplifier Model: DSP8-130 MKII Customer Name:	Dealer Name: Installer Name: Installation Date: Firmware Version: V1.78 Serial Number: 930941707H40109

## IP Setup

### DHCP On/Off

DHCP ON/OFF is the first option in IP SETUP. All Sonance DSP series amplifiers ship with DHCP (Dynamic Host Connection Protocol) ON. In most installations DHCP should be left ON except when you are using a control system for IP control. If you are controlling the DSP series amplifier using IP, then we suggest you turn DHCP OFF and use a static IP address.

IP SETUP	IP Address	192.168.1.2
	IP Subnet Mask	255.255.255.0
	DHCP	ON

### IP Address

The second setting in the IP SETUP section is the IP address. When DHCP is ON the current IP address will be displayed. To change the IP address DHCP must be set to OFF.

When DHCP is turned off the IP address that the router assigned to the amplifier will still be applied. This IP address is a good place to start since it is not being used by another network device. If you wish to change the IP address you should perform a scan of the network and only assign an unused IP address within the range of your router. As a general rule only change the last three digits of the IP address in the amplifier settings and only assign numbers between 2 and 254. Following this suggestion will minimize the chance of making the amplifier inaccessible.

It is critical to type in the correct IP address. If the wrong IP address is entered, the amplifier could become inaccessible. Make changes to the IP settings only if you fully understand network setup.

### Resetting DHCP

If the IP address is not known and the amp is locked out, use the DHCP Reset method in Appendix A.

### IP Subnet Mask

The third setting in the IP SETUP section is the IP Subnet Mask. This is an advanced network setup function. Under most circumstances this field should not need to be edited. Making changes in this field should only be done by an experienced network administrator.

### ID Amp Mode

When the power switch is turned ON, the power button on the front of the amplifier will flash to indicate which amplifier you are programming. This will make the amplifier easy to identify in a multi-amp installation.

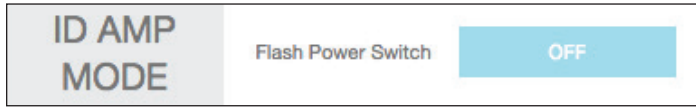

### Backup Restore

The green BACKUP and RESTORE buttons take all of the settings of the amplifier including the DSP settings and encapsulates them into one file. This allows you to transfer these settings into another amp of the same model with the same firmware version. This is a proprietary file type (.bin file), agnostic to PC or Mac.



### Print

The print button will output a complete list of all settings for the amplifier. It is always a good idea to keep a backup hard copy of the settings for each installation.



### Auto On

Select the Auto On method you would like to use with the blue pull down menu. During setup it is strongly recommended that you keep the Auto On method set to POWER BUTTON to prevent the amplifier from shutting off. You can return at anytime to the Auto On setting and select the final method of Auto On for your installation. When controlling the amplifier using IP and IR commands we suggest using the Power Button Auto On mode. See Appendix B.

#### Audio

In the Audio Auto On mode, there are three sleep mode options (off, 15 minutes, 3 hours). Each channel has an independent sleep mode setting. The sleep mode is triggered by an audio sensing circuit on each channel of the amplifier. The minimum input sensing level is 0.5mV.

#### Audio Green

In the Audio Auto On mode the amplifier will power off after 15 minutes without an audio signal present on any of the channels. When an audio signal is applied the amplifier will take approximately 9-12 seconds for the amplifier to reproduce audio after going through its power up sequence. In the audio Auto ON mode the sleep function is active, see sleep mode note below. This mode complies with EU energy saving standards.

**NOTE: WHEN AUDIO GREEN MODE IS ENABLED AND THE AMPLIFIER IS ASLEEP, IP COMMANDS CANNOT BE RECEIVED.**

### Power Button

When sleep mode is set to OFF the channel will be on at all times. Use the sleep mode OFF setting for audio signals like a doorbell or paging where audio must be reproduced immediately at any time.

### Voltage

In the Voltage Auto On mode, the amplifier will power off immediately when the trigger voltage has been removed. When a 3-30V AC or DC voltage is sent to the amplifier, it will take 6-8 seconds for the amplifier to reproduce audio after going through its power up sequence. This mode complies with EU energy saving standards.

### Voltage Green

In the Voltage Green Auto On mode the amplifier will power off immediately when the trigger voltage has been removed. When a 3-30V AC or DC voltage is sent to the amplifier it will take 6-8 seconds for the amplifier to reproduce audio after going through its power up sequence. In Voltage Green mode the Ethernet connection is not active when the amplifier is off! This mode complies with EU energy saving standards.

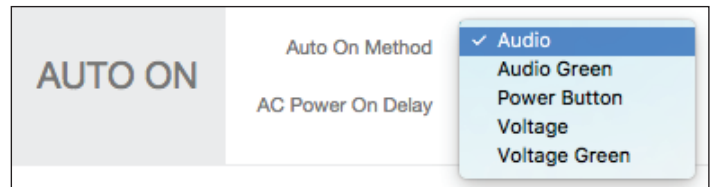

### Sleep Mode

Sleep mode allows you to select how long the amplifier will stay active after the Auto ON method ceases.

#### Off

When set in the OFF mode the channel will be on at all times. Use the OFF setting for audio signals like a doorbell or paging where audio must be reproduced immediately at any time.

#### After 15 Minutes

When an audio signal has not been present on a channel for 15 minutes, the channel will go to sleep. From the sleep state the channel will take approximately 2-3 seconds to reproduce audio again. This mode is similar to legacy Sonamp Auto-On operation.

#### After 3 Hours

When an audio signal has not been present on a channel for 3 hours, the channel will go to sleep. From the sleep state the channel will take approximately 2-3 seconds to reproduce audio again when audio is detected.. This mode works well for home theater installations.

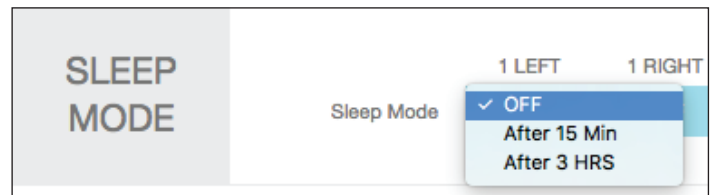

### Info

The orange blocks are installer entered data. Each field has a maximum of 15 characters.

INFO	Amplifier Name	DSP 8-130 MKII	Dealer Name		Firmware Version	V1.78
	Amplifier Model	DSP8-130 MKII	Installer Name		Serial Number	930941707HAD109
	Customer Name		Installation Date			

## In/Out Settings Tab

The IN/OUT settings tab is used to assign your MKII's input and output specifications.

### Input Setup

#### Input Name

This is a user entered field with a maximum of 15 characters. Use these fields to describe the type of input connected.

#### Input Trim dB

This pull down menu allows for input levels to be adjusted +/-6dB. This gives you the ability to level out all your inputs so when you switch from input to input the levels will be equal. This can eliminate any harsh transitions between sources with different output voltages. Select the pull down menu in each channel to adjust the level trim between plus or minus 6dB in increments of 0.5dB.

INPUT SETUP	1 LEFT		1 RIGHT		2 LEFT		2 RIGHT		3 LEFT		3 RIGHT		4 LEFT		4 RIGHT	
	Input Name	Sonos	Sonos	Door Bell	Door Bell	TV	TV	Input 4L	Input 4R	Level Trim dB	0	0	0	0	0	0
		0	0	0	0	0	0	0	0	0	0	0	0	0	0	0

### Output Setup

#### Output Name

This is a user entered field with a maximum of 15 characters. Use these fields to describe the location of the speakers.

#### Stereo/Mono

Allows each channel to be set for Stereo or Mono operation. When Mono is selected, the Left and Right of the input selected will be combined to create Mono.

#### DSP Preset

Apply any of the available Sonance DSP presets to each channel of the amplifier independently. You can apply any open preset & then make modifications on the EQ settings page.

#### Output Group

The DSP 2-150 MKII has eight output group options: A-H. When using IP or IR to control the amplifier, commands are sent to an output group and not to a specific channel.

#### Bridge Mode

When more power is required, two channels can be bridged. Follow the instructions on page 5, in the software, for connecting the wires then select Bridge ON.

OUTPUT SETUP	1 LEFT		1 RIGHT		2 LEFT		2 RIGHT		3 LEFT		3 RIGHT		4 LEFT		4 RIGHT	
	Output Name	Output 1L	Output 1R	Output 2L	Output 2R	Output 3L	Output 3R	Output 4L	Output 4R	Bridge Mode	OFF	OFF	OFF	OFF	OFF	OFF
	Stereo/Mono	Stereo	Stereo	Stereo	Stereo	Stereo	Stereo	Stereo	Stereo							
	DSP Preset	VP56R	VP56R	BPS8	BPS8	ISW	ISW	IS4	IS4							
	Output Group	A	A	B	B	C	C	D	D							
	Bridge Mode	OFF	OFF	OFF	OFF	OFF	OFF	OFF	OFF							

### Output Source

#### Source 1

This is the primary source you will direct to the speakers. Any of the inputs available on the amplifier can be selected. When channels are in the same output group, the inputs will all change in unison. Left inputs default to left outputs and right inputs to right outputs.

#### Source 2

This is a secondary source that based on the mode Source 2 setting described below, will either override or mix with Source 1. This input could be used for a doorbell or paging for example.

#### Mode Source 2 Off

When set to OFF, Source 2 has no effect on the operation of the channel.

#### Mix

When set to MIX, Source 1 and Source 2 will be blended together when a signal is present on Source 2.

#### Mute

When set to MUTE, Source 1 will be muted while Source 2 is active.

OUTPUT SOURCE	Source 1		Door Bell		TV		Input 4L		Input 4R	
	Sonos	Sonos	Door Bell	Door Bell	TV	TV	Input 4L	Input 4R	Input 4L	Input 4R
	Sonos	Door Bell	Door Bell	Door Bell	TV	TV	Input 4L	Input 4R	Input 4L	Input 4R
	Mode Source 2	MIX	MUTE	OFF	OFF	OFF	OFF	OFF	OFF	OFF

### Output Volume

This is the main volume level control for each channel. When channels are placed in the same output group the levels will change simultaneously.

**NOTE: FRONT PANEL VOLUME CONTROLS OVERWRITE THIS SETTING.**

#### Turn On Volume

This determines what volume level the amplifier will default to when it is turned on. Channels placed in the same output group will automatically have identical levels. Turn on volume level is implemented when the amplifier is turned off with the power switch or goes into sleep mode.

**NOTE: FRONT PANEL VOLUME CONTROLS OVERWRITE THIS SETTING.**

#### Maximum Volume

IP or IR can be used to limit how loud the speakers will play in certain areas. Output Volume and Turn On Volume can never exceed the Maximum Volume. Maximum Volume is the highest volume level that the amplifier will output. The output group selected does not affect this setting.

#### Gain Offset

The gain offset setting allows channels in the same output group to have their levels adjusted independently by +/-6dB. This is an independent setting not affected by the output group.

#### Mute

The mute setting eliminates the output from the speakers. Channels placed in the same output group will change simultaneously.

OUTPUT VOLUME	Output Volume	12	12	12	12	12	12	12	12
		Turn On Volume	12	12	12	12	12	12	12
	Maximum Volume	-10	-10	12	12	12	12	12	12
	Gain Offset	-3	-3	0	0	0	0	0	0
	Mute	OFF	OFF	OFF	OFF	OFF	OFF	OFF	OFF

### EQ Setting Tab

The EQ settings tab is used to assign your DSP EQ presets for each channel. EQ presets provide best possible audio quality for most Sonance speakers. EQ presets are available at <http://www.sonance.com/electronics/amplifiers/dsp>.



## Assign Preset

### Output Name

These can be named Output 1L & Output 1R or room names such as Kitchen L and Kitchen R. These are a duplicate of the output name on the IN/OUT settings page.

### DSP Preset

Select your DSP preset with the blue pull down menu. This will auto populate in the IN/OUT settings page.

ASSIGN PRESET	1 LEFT		1 RIGHT		2 LEFT		2 RIGHT		3 LEFT		3 RIGHT		4 LEFT		4 RIGHT			
	Output Name	Output 1L	Output 1R	Output 2L	Output 2R	Output 3L	Output 3R	Output 4L	Output 4R	DSP Preset	VP50R	VP50R	BP5S	BP5S	ISW	ISW	ISA	ISA

## Test Signal

The SonARC software includes a built in pink noise generator. The pink noise signal can be used in conjunction with a real time analyzer to measure speakers.

### Test Signal Select

You have the option of pink noise or test signals fed into line level inputs. Use the blue pull down menu to select between pink noise or line level inputs as a source for the test signal.

### Volume

Select your desired volume.

### On/Off

Toggle between on and off. The pink noise signal should not be left on for more than 10 minutes to minimize the risk of damaging the speakers.

**NOTE: THE PINK NOISE GENERATOR IS AFTER THE AUDIO SENSORY CIRCUIT SO THE AMP WILL GO TO SLEEP DEPENDING ON THE AUTO ON MODE SELECTED. IF THE PINK NOISE STOPS, POWER CYCLE THE AMP.**

TEST SIGNAL	Test Signal Select	Pink Noise	Pink Noise	Pink Noise	Pink Noise	Pink Noise	Pink Noise	Pink Noise	Pink Noise
	Volume	-20	-20	-20	-20	-20	-20	-20	-20
	On / Off	OFF	OFF	OFF	OFF	OFF	OFF	OFF	OFF

## DSP Preset Editor

### Select Preset or Edit

This section allows you to edit any of the 50 existing presets. Select the preset you want to edit from the drop down menu.

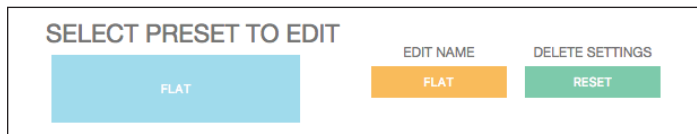

### Edit Name

Edit the name of your preset with up to 15 characters.

### Delete Settings

The Reset button deletes the selected preset.

## Import Export

### All Presets

The green IMPORT EXPORT buttons allow you to save all 50 presets in one file. This option can be useful when setting up multiple amplifiers.

### Single Preset

The green IMPORT EXPORT buttons allow you to import or export presets individually.

## Export Single Preset

1. Use the blue pull down menu SELECT PRESET to edit located above the IMPORT EXPORT green buttons.
2. Select the preset you choose to export from the pull down menu.
3. Press the green EXPORT button. Depending on your web browser, the exported file will be saved in your downloads folder or you will be prompted where you would like to save the file.

## Import Single Preset

1. Import speaker preset to a location on your computer. This can be accomplished by saving a DSP preset downloaded from Sonance website.
2. Select the location you would like to store the new preset using the SELECT PRESET TO EDIT pull down menu. You can save the new preset in any of the open preset locations or you can overwrite an existing preset you do not need.
3. Press the green IMPORT button.
4. From the pop-up menu choose local or internet.
5. You will be directed to My Computer (Windows) or Finder (MAC).
6. Find & select the new preset you would like to import (eqs).
7. You will be directed to a screen that says upload successful.
8. Press "Click Here To Go Back".
9. The preset will now be saved in the location you selected.

**NOTE: PRESETS DOWNLOADED FROM INTERNET CAN TAKE UP TO 15 SECONDS TO DOWNLOAD.**

## Copy Preset

From/To the blue pull down menus allow you to pull a preset from one location and assign it to another location. Press green copy button to activate.



## Output Frequency Response

This graph reflects the changes made below.

The EQ image shows EQ4 ON at 500Hz, the Q is set to 3 with a -6dB gain, creating a gradual dip in the lower midrange.

EQ9 shows ON at 3000Hz, the Q is set to 10 with a -6dB gain, creating a sharp dip in the midrange.

EQ10 shows ON at 10000Hz, the Q is set to 1 with a +4dB gain, creating a very gradual slope in the high frequencies.

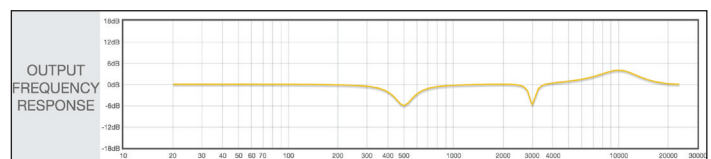

## Parametric EQ

All Sonance DSP amplifier models feature a 10 band parametric EQ. Adjustments made to the EQ will be displayed on the output frequency response graph. We strongly suggest not adjusting the EQ without proper measurement equipment.

### EQ On/Off

Turns each of the 10 parametric EQ filters on and off.

### EQ Frequency Hz

Enter the center frequency (20Hz - 20kHz) for the filter to be adjusted.

### EQ-Q

This setting determines the width of the adjustment range. The lower the number the wider the bandwidth. The higher the number the narrower the bandwidth.

### EQ-Gain +/- dB

The level of each parametric adjustment can be set +/-12dB. Careful adjustment of the EQ gain is necessary to prevent damage to the speakers. Always increase the level as little as possible. The first choice should always be to reduce the output to achieve the target frequency response.

PARAMETRIC EQ	EQ - On/Off	EQ1	EQ2	EQ3	EQ4	EQ5	EQ6	EQ7	EQ8	EQ9	EQ10	
	EQ Frequency Hz	1000	1000	1000	1000	1000	1000	1000	1000	1000	1000	1000
	EQ - Q	1	1	1	1	1	1	1	1	1	1	1
	EQ - Gain +/-dB	0	0	0	0	0	0	0	0	0	0	0

## Delay

Delay is shown in milliseconds, feet and meters. You can make an entry in any of the three fields and the other fields will be calculated automatically. The minimum delay is .01 milliseconds, the maximum delay is 12 milliseconds. This function is useful when compensating for distance between satellites and subwoofers for instance.

**DELAY**

m Sec

Feet

Meters

## Tilt Control

The tilt controls are very sophisticated bass and treble control. By selecting a start frequency and level you can ramp the bass and or treble up or down. The effect of the tilt control is visible in the output frequency response graph.

### Low Tilt/High Tilt

This setting turns the low and high tilt controls on and off.

### Frequency

Enter the start frequency of the tilt in Hz. To boost the low frequencies you would typically set the low tilt to 100Hz. To boost the high frequencies you would set the high tilt to around 5kHz.

### Gain

The gain can be set in 1dB steps +/-12dB. When setting the gain use as little positive gain as possible to minimize the risk of damage to the loudspeakers.

**TILT CONTROL**

Low Tilt  High Tilt

Frequency   Frequency

Gain   Gain

## Crossover

### LP Xover / HP Xover

This setting turns the high and low pass crossovers on and off.

### Frequency

In this field you can enter any frequency between 20Hz-20kHz.

### Filter Type

6dB, 12dB, 18dB and 24dB per octave Butterworth filters are available in the pull down menu. The higher the number the faster the speakers output will be reduced below or above the crossover frequency. In a typical satellite subwoofer system the crossover frequency would be around 80-100Hz for both the high and low pass filters.

**CROSSOVER**

LP Xover   HP Xover

Frequency   Frequency

Filter Type   Filter Type

## Limiter

The limiter operates as a brick wall limit on the output of the amplifier. The limiter drop down menu has -3dB, -6dB and -12dB options. The maximum outputs for each of the models:

	No Limiter	-3dB	-6dB	-9dB
MKII	150 watts	75 watts	37.5 watts	18.25 watts

All of the above output power ratings are when connected to an 8 Ohm load.

**LIMITER**

Level

# Specifications

## SONAMP DSP 2-150 MKII

Number of Channels	2 (1 stereo pair)
Power Output - 8 ohms (Stereo)	150 Watts RMS per channel (all channels driven)
Power Output - 4 ohms (Stereo)	224 Watts RMS per channel (all channels driven)
Power Output - 8 ohms (Bridged)	473 Watts
Frequency Response	5Hz – 50kHz, bandwidth limited
Total Harmonic Distortion	0.07% (1kHz, 8 ohms) 0.06% (1kHz, 4 ohms)
Signal to Noise Ratio	-100dB (20Hz-20kHz)
Input Gain	29dB
Input Sensitivity	100mV for 1 Watt Output @8 ohms 1230mV for 150 Watts Output @8 ohms
Input Impedance	20k ohms
Loop Output Impedance	600 ohms
Maximum Source Input Voltage	2.9V VAC RMS
Communication Protocol	TCP/IP (RJ-45 10/100 Base T)
Power Consumption 120V AC	
@8 ohms (sinewave, full power)	371 Watts (all channels driven)
@4 ohms (sinewave, full power)	392 Watts (all channels driven)
@8 ohms (sinewave, 1/8 power)	72 Watts (all channels driven)
@4 ohms (sinewave, 1/8 power)	74 Watts (all channels driven)
@Idle	17 Watts
@IP or IR standby	1.5 Watts
@Standby	0.48 Watts
Power Consumption 220V AC	
@8 ohms (sinewave, full power)	359 Watts (all channels driven)
@4 ohms (sinewave, full power)	376 Watts (all channels driven)
@8 ohms (sinewave, 1/8 power)	69 Watts (all channels driven)
@4 ohms (sinewave, 1/8 power)	71 Watts (all channels driven)
@Idle	15 Watts
@IP or IR standby	1.1 Watts
@Standby	0.5 Watts
Heat Output	
@8 ohms (sinewave, full power)	242 BTU (all channels driven)
@4 ohms (sinewave, full power)	314 BTU (all channels driven)
@8 ohms (sinewave, 1/8 power)	118 BTU (all channels driven)
@4 ohms (sinewave, 1/8 power)	124 BTU (all channels driven)
AC Voltage	100-120V@60Hz, 220-240V@50Hz
AC Fuse	5A (T5-AL)
Rack Space Requirement	1U – 1/2 Rack Width
Dimensions w/ Feet (W x H x D)	8 5/8" x 2 1/8" x 16 13/16" (219mm x 54mm x 427mm)
Dimensions w/ Rack Ears w/o Feet (W x H x D)	19" x 1 3/4" x 16 13/16" (482mm x 44mm x 427mm)
Shipping Weight	11 lbs (5.0kg)



CAD Files available for download at [www.sonance.com/electronics/amplifiers/dsp](http://www.sonance.com/electronics/amplifiers/dsp)



## APPENDIX A

LED Indicator	Explanation
Dim White Power Button	Amplifier is plugged in and in standby mode.
Bright White Power Button	Amplifier is active.
Power Button Blinking	The amp is in ID Amp Mode (see page 9).
Green LED	Signal is present (>1.0mv) on channel.
Blinking Green	Signal is going above and below the active level or between songs.
Blinking Red	The channel is being over driven.
Solid Red	The amp is in protection mode (see page 6).
Power Button Blinking Light +LED's Blinking Red	Amp temperature exceeds the design maximum.
DHCP Reset Step	DHCP Reset Steps
Step 1	Turn amplifier off.
Step 2	With light pressure adjust 1L Volume Control full counter clockwise.
Step 3	With light pressure adjust 1R Volume Control full clockwise.
Step 4	Power on amplifier (wait for Power Button to show a series of flashes).
Step 5	Turn amplifier off.
Step 6	Set the 1L Volume Control full clockwise or at desired volume level.
Step 7	Power on amplifier.
Amplifier Factory Reset	Amplifier Factory Reset Steps
Step 1	In a URL address window enter the amplifiers IP address with the extension /Update.htm (ex. 192.168.1.100/Update.htm)
Step 2	On the update page, locate the red reset button. Use this button to completely reset the amplifier.
Step 3	Return to the Home Page to set up the amplifier. Note: EQ presets will not be deleted.

## APPENDIX B

DSP 2-150 MKII Amplifier - Auto On/Sleep Mode Details			
Auto On Setting	Sleep Mode Options	Time To Music	Ethernet
Audio	Off	Always on	Always on
Audio	15 Min	6-8 seconds	Always on
Audio	3 Hrs	6-8 seconds	Always on
Auto On Setting	Sleep Mode Options	Time To Music	Ethernet
Audio Green	None	6-8 seconds	Turns off after 15 mins without audio
Auto On Setting	Sleep Mode Options	Time To Music	Ethernet
Power Button	Off	Always on	Always on
Power Button	15 Min	2-3 seconds	Always on
Power Button	3 Hrs	2-3 seconds	Always on
Auto On Setting	Sleep Mode Options	Time To Music	Ethernet
Voltage	None	6-8 seconds	Always on
Auto On Setting	Sleep Mode Options	Time To Music	Ethernet
Voltage Green	None	6-8 seconds	Turns off after 15 mins without voltage

# Out of the Box Troubleshooting

## No Power

Front panel Power LED does not illuminate when AC cord is plugged into an outlet and the amp is switched on.

### Cause:

**AC cable is improperly seated either at the back of the amp or at the AC outlet.**

### Solutions:

- Verify that both ends of the power cable are securely seated.

### Cause:

**There is no AC current at the outlet.**

### Solutions:

- Securely insert the AC cord into another known-working AC outlet.

### Cause:

**A rear panel fuse is blown.**

### Solutions:

- Check the rear panel fuse and replace if blown. If the front panel power LED still does not illuminate, contact Dana Innovations Technical Support for additional instructions.

## No Audio

Front panel Power LED illuminates but the amp will not pass audio.

### Cause:

**Current selected source is not transmitting an audio signal into the amp.**

### Solutions:

- Verify that the source is powered on, operating and not in a muted or paused state.

### Cause:

**Audio interconnect cables are not pushed-in securely at the source, at the preamp and/or at the amp's input connectors.**

### Solutions:

- With the amp powered of, carefully reseal each of the RCA connections at the source, at the preamp/zone controller and at the input of the Sonamp.

### Cause:

**The line level interconnect cables are defective.**

### Solutions:

- Substitute another interconnect cable for the source to preamp and/or preamp to Sonamp.

### Cause:

**The speaker wires at either the output of the amp or at the speaker location are not securely connected.**

### Solutions:

- Reattach the speaker wires on the 4-terminal speaker block connectors on the rear panel of the Sonamp.

### Cause:

**The amp's power management option state is not being met (amp is set to voltage trigger and is not receiving a voltage).**

### Solutions:

- Verify/reset the power management option to 'Power Button'.

### Cause:

**The SonARC bridging option is engaged but the speakers are not wired properly for bridge mode.**

### Solutions:

- Set the bridge mode to OFF. If audio output is still unavailable, contact Dana Innovations Technical Support.

## No IP Control

Ethernet connection is made but IP control is not responding.

### Cause:

**Faulty ethernet cable.**

### Solutions:

- Check the rear-panel network LEDs on the input card are flashing to indicate network connectivity. If these LEDs are not active, replace the Ethernet cable. If the network LEDs are active but the DSP amp will not respond, perform the network reset as described below and retest.

### Cause:

**Faulty network switch.**

### Solutions:

- Connect the amp directly to the network router, bypassing the network switch.

### Cause:

**The amp's IP address is improperly set.**

### Solutions:

- Scan the network, find the DSP amp's IP address and enter it into your web browser. SonARC set-up software should populate, showing the DHCP network address assigned to the amp by the router. In the Advanced Settings tab in SonARC, turn-off DHCP and set the fixed IP address of your choosing. Enter this IP address in your IP control module. Test the system with your control devices (touchscreens, iPhones with app, etc.).
- If the LEDs are still inactive and the other network devices are working properly, then the input card may need to be replaced, contact Dana Innovations Technical Support. If the network LEDs are active but the DSP amp will not respond, perform the network reset as described below and retest.

## No IR Control

The IR output from the control system is connected to the 'IR Control Input' jack of the DSP amp with a mono-mini cable (not a stereo mini cable) but the amp will not respond to IR commands.

### Cause:

**The DSP amp does not respond to IR commands using the mono-mini input jack.**

### Solutions:

- Test the IR sending component by plugging a mini-emitter into its output and using the emitter to control a local AV component (such as a DVD player or AV receiver). Verify that the 'IR Status' LED near the IR Control Jack illuminates when an IR command is sent, indicating that the Amp is receiving the signal.
- If the local AV component can be controlled by the mini-emitter, then the problem may be caused by outdated firmware. Request the latest firmware from Dana Innovations Technical Support.

## Channel Out

One channel of the amp does not have output.

### **Cause:**

**Line-level interconnect cable from the source to the affected amp channel is loose, disconnected or faulty.**

### Solutions:

- Verify that the interconnect cables are properly seated at both the amp end inputs and source end outputs. Disconnect both interconnects on the amp end (1L and 1R input connections on the amp).
- Connect the functioning channel's cable from the source to the non-functioning channel's input jack on the amp (for example, if 1L is faulty, connect 1R's cable to the 1L input jack and test).
- Test playback to see if the speaker connected to the non-functioning channel works.
- If the affected channel is now working, the problem could be with that channel at the source or with the interconnect cable for the non-functioning channel.
- Replace the affected channel's interconnect cable and retest. Test source on another audio system to confirm channel outputs are functioning.

### **Cause:**

**Speaker wire leading out to the channel is loose, disconnected or faulty.**

### Solutions:

- Verify proper connection of the speaker wire at amp end and speaker end. If the channel is still inoperative, disconnect the speaker wire from the non-functioning channel at both the amp end and speaker end. Connect a new, test speaker wire from the affected amp channel output to the speaker or to a new, test speaker. If the affected channel is now working, the problem must be the speaker wire; replace with a new speaker wire. If the affected channel is still not working, the affected channel in the amp could be defective; contact DI Technical Support for next steps.

## Protection LEDs are Illuminated

One or more red protection LEDs are on.

### **Cause:**

**The problem could be DC on the input of the amplifier.**

**A short on the speaker wire going out to the zone.**

**A short at the speaker itself.**

### Solutions:

- Disconnect the speaker wire from that channel going out to the zone.
- If the protection LED goes out, connect your local test speaker, turn the amp back on and play music.
- If the test speaker produces sound, then the speaker wire leading out to the zone or at the zone speaker is shorted.
- If the test speaker does not produce sound and you've tried a different source on that pair of amp channels to rule-out a defective source, then the amp requires service; contact Dana Innovations Technical Support for additional instructions.

## Factory Reset

Perform a factory reset procedure on the DSP amp using a small flat head jewelers screwdriver.

### Solutions:

- With the amp powered OFF, carefully rotate the front panel accessed 1L volume control fully-counterclockwise and rotate the 1R volume control to fully-clockwise.
- Press the power switch to turn the amp ON.
- Wait approximately 20 seconds for the reset to complete--power switch LED on continuously.
- Turn the amp OFF.
- Reset the 1L volume control to maximum.
- Turn the amp ON.

For additional support, contact Dana Innovations Technical Support [www.techsupport@sonance.com](mailto:www.techsupport@sonance.com).

## LIMITED TWO (2) YEAR WARRANTY

Sonance warrants to the first end-user purchaser that this Sonance-brand product (product), when purchased from an authorized Sonance Dealer/Distributor, will be free from defective workmanship and materials for the period stated below. Sonance will at its option and expense during the warranty period, either repair the defect or replace the Product with a new or remanufactured Product or a reasonable equivalent.

## EXCLUSIONS

**TO THE EXTENT PERMITTED BY LAW, THE WARRANTY SET FORTH ABOVE IS IN LIEU OF, AND EXCLUSIVE OF, ALL OTHER WARRANTIES, EXPRESS OR IMPLIED, AND IS THE SOLE AND EXCLUSIVE WARRANTY PROVIDED BY SONANCE. ALL OTHER EXPRESS AND IMPLIED WARRANTIES, INCLUDING THE IMPLIED WARRANTIES OF MERCHANTABILITY, IMPLIED WARRANTY OF FITNESS FOR USE, AND IMPLIED WARRANTY OF FITNESS FOR A PARTICULAR PURPOSE ARE SPECIFICALLY EXCLUDED.**

No one is authorized to make or modify any warranties on behalf of Sonance. The warranty stated above is the sole and exclusive remedy and Sonance's performance shall constitute full and final satisfaction of all obligations, liabilities and claims with respect to the Product.

**IN ANY EVENT, SONANCE SHALL NOT BE LIABLE FOR CONSEQUENTIAL, INCIDENTAL, ECONOMIC, PROPERTY, BODILY INJURY, OR PERSONAL INJURY DAMAGES ARISING FROM THE PRODUCT, ANY BREACH OF THIS WARRANTY OR OTHERWISE.**

This warranty statement gives you specific legal rights, and you may have other rights which vary from state to state. Some states do not allow the exclusion of implied warranties or limitations of remedies, so the above exclusions and limitations may not apply. If your state does not allow disclaimer of implied warranties, the duration of such implied warranties is limited to period of Sonance's express warranty.

Your Product Model and Description: Sonamp DSP 2-150 MKII Multi-Channel Power Amplifier.

Warranty Period for this Product: Two (2) years from the date on the original sales receipt or invoice or other satisfactory proof of purchase.

Additional Limitations and Exclusions from Warranty Coverage: The warranty described above is non-transferable, applies only to the initial installation of the Product, does not include installation of any repaired or replaced Product, does not include damage to allied or associated equipment which may result for any reason from use with this Product, and does not include labor or parts caused by accident, disaster, negligence, improper installation, misuse (e.g. overdriving the amplifier or speaker, excessive heat, cold or humidity), or from service or repair which has not been authorized by Sonance. Obtaining Authorized Service: To qualify for the warranty, you must contact your authorized Sonance Dealer/Installer or call Sonance Customer Service at (949) 492-7777 within the warranty period, must obtain a return merchandise number (RMA), and must deliver the Product to Sonance shipping prepaid during the warranty period, together with the original sales receipt, or invoice or other satisfactory proof of purchase.



©2018 Sonance. All rights reserved.

Sonance is a registered trademarks of Dana Innovations.

Due to continuous product improvement, all features and specifications are subject to change without notice.

For the latest Sonance product specification information visit our website: [www.sonance.com](http://www.sonance.com)

SONANCE • 991 Calle Amanecer • San Clemente, CA 92673 USA  
(949) 492-7777 • FAX: (949) 361-5151 • Technical Support: (949) 492-7777

[www.sonance.com](http://www.sonance.com)

11.12.18